



more languages on:
www.euro-security.info



ESP



EURO SECURITY
PRODUCTS®

SECURITY PRODUCTS FOR REAL PROFESSIONALS

since 1992

WHAT CAN YOU FIND IN THIS CATALOGUE?

Expandable batons + holders + accessories	4
Equipment for training	12
Standard straight police batons / Tonfas	13
Palm-stick / Tactical pens	15
Spray flashlights TORNADO and HURRICANE	16
Defensive pepper sprays + holders	17
Stun guns + holders	21
Police shields / Capture shield	22

Detection mirrors	25
Textile disposable handcuffs + holders	26
Metal handcuffs + holder	27
Tactical flashlights + holders / Night police set	28
Tactical backpack / Duty belt	32
Accessories for firearms	32
Pistol and rifle magazine holders	33
Tactical targets series	35

COMPREHENSIVE SYSTEM OF ESP FIXING CLIPS

We would like to introduce our comprehensive system of fixing clips. Most of our holders can be supplied **with different clips** so that the ESP holder **exactly fits your needs**.

Holders with these clips can be placed on a duty belt, tactical vest or an item with MOLLE. The majority of these clips allow holder **rotation in full 360° range**, which is already a typical feature of our holders. You can choose from the following fixation clips:

UBC-01

This type of clip enables rapid attachment of the holder to a belt **with one hand only** and **without the necessity of unbuckling the belt**. The holder **can be rotated** in respect to the belt by full circle of 360 degrees with 16 locking positions. This clip is **patented** in Europe, in the USA and in Russia.

UBC-02

This flat quick-fastening clip enables rapid attachment of the holder to a belt **with one hand only** and **without the necessity of unbuckling the belt**. In comparison with fixing clip **UBC-01**, the distance between the belt and the holder is smaller with this type of clip. The holder **can be rotated** in respect to the belt by full circle of 360 degrees with 16 locking positions. It can be alternatively **fastened to MOLLE MIL STD webbing**.

paddle Fobus

This “paddle” type of fixture from the renowned company **Fobus** enables comfortable carrying of the holder. The paddle has been designed for **carrying on ordinary clothes** and it tightly fits the user’s body.

Its special bent shape firmly secures the holder during carrying. This clip, as one of only a few of paddle type clips on the market, also enables **smooth rotation** in respect to the belt in full circle of 360°, with 16 locking positions.

UBC-03

The holder is attached in the usual way **by slipping the belt through the hole** in the clip. The clip **can be adjusted to the belt width** by an adjustable stop with two screws. The holder **can be rotated** in respect to the belt by full circle of 360 degrees with 16 locking positions. Its **design is patented** in the USA and in Europe.



UBC-04



This type of clip allows **secure and firm fixation** of ESP holders to a **MOLLE webbing** with the possibility of **360° rotation and fixing in 16 locking positions**.

ESP holders (supplied with UBC-04 clip) can be attached to any present-day **tactical/ballistic vest or tactical backpacks** just by inserting the plastic fixing plug of the UBC-04 into the MOLLE straps.

Its **design is patented** in the USA, in Europe and in China.

UBC-05



This universal belt clip enables the user to **quickly change** between different plastic and nylon ESP holders with rotation mechanism. The clip itself **remains fastened to the belt** – you only need to click on the holder of choice. *You can find more information about the Quick Change System below.*

The holder **can be rotated** in respect to the belt by full circle of 360 degrees with 16 locking positions.

The belt is **pulled through the opening** in the body of the clip. The holder is then slid onto the clip and secured with locking mechanism. The clip **can be adjusted to belt width** from 32 mm to 60 mm with the use of an adjustable stop with two screws.



UBC-05 →

UBC-04 →



metal clip →



metal clip

The metal clip enables **rapid attachment** of the holder to a belt (**without the necessity of unbuckling it**) or to a **tactical vest**.

UBC-07



This type of clip enables the user to **quickly change** between different plastic and nylon ESP holders with rotation mechanism. The clip itself **remains fastened to a MOLLE webbing** – you only need to click on the holder of choice. *You can find more information about the Quick Change System below.*

The holder can also be permanently fixed to the clip thanks to the second rotation mechanism. The holder **can be rotated 360 degrees** with 16 locking positions in both cases.

ESP holders (supplied with UBC-07 clip) can be attached to any present-day **tactical/ballistic vest or tactical backpack** just by inserting the plastic fixing plug of the UBC-07 into the MOLLE straps.

UBC-07 →



Quick Change System (used by UBC-05 and UBC-07 clip)

Thanks to this highly flexible system, the user is able to change his or her equipment **according to the particular needs** at a given moment. A baton holder can be switched for a flashlight holder or for a magazine holder. In case of need – for example when the police officer is busy with administrative work – the holders that are currently not necessary can be put away completely.



You can fit various ESP rotating holders on the clip and change them according to your momentary needs.

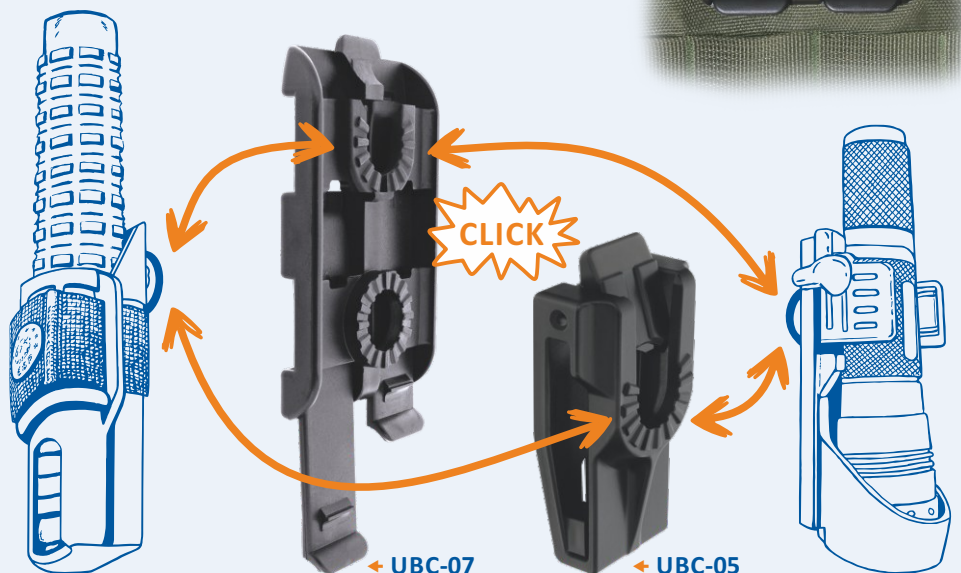

ESP EXPANDABLE BATONS

Hardened expandable batons – 16", 18", 21", 23" and 26"

Our hardened expandable batons (ExB) are intended for **professional use** by the police and other authorities in extreme conditions. They are opened by a sharp flick and stay firmly fixed in this position. ESP expandable batons meet the **requirements of the German standard** for expandable batons.

The tubes of hardened batons are made from a superior material, which is **hardened** by heat treatment. The hardened batons are **highly resistant to deformation** if the baton is exposed to a hard stroke. Surface finish is **black nickel-zinc** (with good resistance to abrasion), or **white chrome**.

Types of handles:

Specially designed **rubber handle** enables a **secure hold**. The rubber material is **certified** for long-term contact with the skin without health risks. Four types of handles are available:

- **anti-slip** handle with a **rough surface** type **H**
Its design significantly decreases any possibility of the baton being yanked from the hand and gives the user a comfortable certitude.
- **anti-slip** handle with a **smoother surface** type **ExB-21HT**
- **ergonomic** handle type **HE**
This handle has an ergonomic shape with a **pleasant smooth** surface.
- **smooth leather-imitation** handle type **ExB-21HL**



↑ ExB-21HL



↑ anti-slip handle – type "H"



↑ ExB-21HT

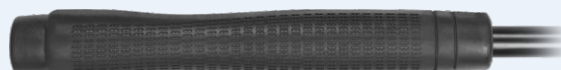

↑ ergonomic handle – type "HE"

Swiveling holder supplied with expandable batons:

The batons are supplied with a **professional swiveling** plastic holder with **Quick Change System**, for which European patent was granted. It **can be rotated** in respect to the belt by full circle of 360 degrees with 16 locking positions. This holder is **included in the price** of the baton.

This holder enables **very quick drawing** of the baton just **with one hand** as there is almost no friction thanks to the automatic opening of the holder after the nylon strap is unfastened. Holder with unfastened nylon strap enables carrying of expanded baton.

The holder is equipped with **UBC-05** belt clip (part of the Quick Change System) which enables the user to **quickly change** between different plastic and nylon ESP holders with rotation mechanism. The clip itself **remains fastened to the belt** – you only need to click on the holder of choice.



↑ BH-55

↑ BH-54

↑ BH-54

Type	Version	Surface finish	Length (closed)	Length (expanded)	Weight	Type of the holder (incl. in the price)		
ExB-16H	ExB-16HE	hardened	black / chrome	6,7" / 170 mm	16" / 405 mm	340 g	BH-54	
ExB-18H	ExB-18HE	hardened	black / chrome	7,1" / 180 mm	18" / 450 mm	370 g	BH-54	
ExB-21H	ExB-21HT	ExB-21HE	hardened	black / chrome	8,3" / 210 mm	21" / 530 mm	440 g	BH-54
ExB-21HL		hardened	black / chrome	8,3" / 210 mm	21" / 530 mm	435 g	BH-54-L	
ExB-23H	ExB-23HE	hardened	black / chrome	9,0" / 230 mm	23" / 585 mm	500 g	BH-55	
ExB-26H	ExB-26HE	hardened	black / chrome	10,2" / 260 mm	26" / 660 mm	540 g	BH-55	



ExB-21HS ExB-18HS ExB-16HS

Compact hardened expandable baton

This **compact metal** version of ESP telescopic baton is designed mainly for **concealed carry**. Thanks to its **significantly reduced dimensions** it is suitable for all kinds of armed and security personnel who **carry out their duties in civilian clothes**.

Unlike major competitive products the ESP product is made from **hardened steel**. The ending is hardened as well, providing the baton with maximum efficiency. You can use it even for **the most demanding missions in extreme conditions**.

The **transverse knurling** provides **firm and secure grasp** of the baton and ensures secure attachment of the metal **clip**. The clip can be freely **moved according to the user's need** or can be removed completely.

The baton **can be fitted with the entire ESP accessory line** which we offer but **with the exception of baton holders**. This baton is designed for free carry without a holder, using only the metal clip.



Type	Version	Surface finish	Length (closed)	Length (expanded)	Weight
ExB-16HS	hardened	black / chrome	6,7" / 170 mm	16" / 405 mm	295 g
ExB-18HS	hardened	black / chrome	7,1" / 180 mm	18" / 450 mm	325 g
ExB-21HS	hardened	black / chrome	8,3" / 210 mm	21" / 530 mm	370 g

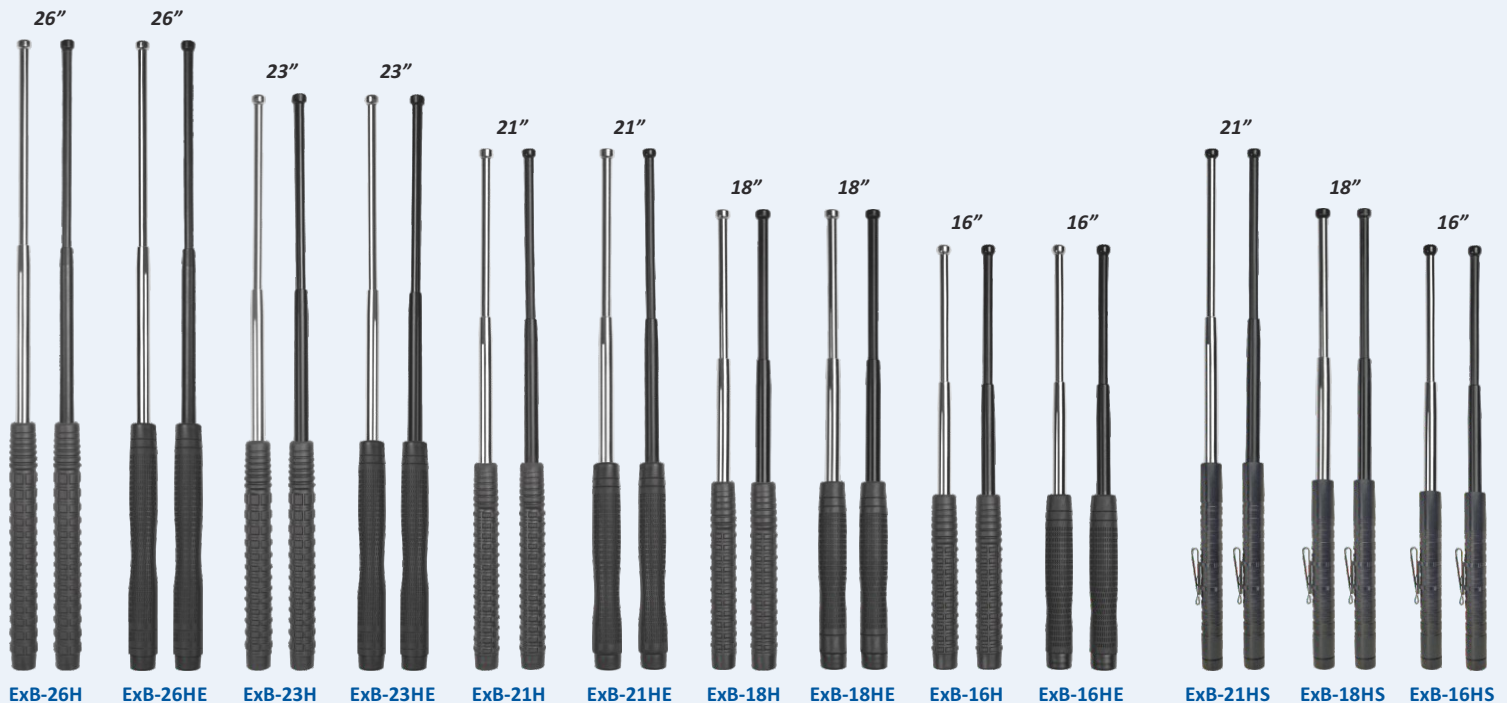

Non-hardened expandable batons – 16" and 21"

The **non-hardened baton** is recommended for **personal self-defense** and is **NOT DESIGNED** for professional use. The batons are produced with black nickel-zinc surface finish (with good resistance to abrasion) or with white nickel finish.

They have top quality durable **rubber grip** with an original **anti-slip** surface. This surface significantly decreases any possibility of the baton being yanked from the hand. A firm grasp of the baton gives the user a comfortable certainty.

Plastic holder, which is included in the price of baton, can be attached to a belt **by slipping the belt through the opening** in the holder. The holder was granted **European patent** and enables very quick drawing of the baton **just with one hand**. When the nylon strap is unfastened, the holder enables **carrying of expanded baton**.

Type	Version	Surface finish	Length (closed)	Length (expanded)	Weight	Type of the holder (incl. in the price)
ExB-16N	non-hardened	black / nickel	6,7" / 170 mm	16" / 405 mm	340 g	BH-02
ExB-21N	non-hardened	black / nickel	8,3" / 210 mm	21" / 530 mm	440 g	BH-02

BH-02 →



Expandable batons in different color versions

The ESP company was the first one in the world to start manufacturing expandable batons in **Desert** and **Khaki** color. Plastic baton holder **BH-02** and **holder for tactical mirror** can be manufactured in these colors as well.



CARRYING EXPANDABLE BATONS

BHU-x4 BHU-x5 Plastic holder for expandable baton

This holder is designated for **professional use**. The unique construction of the holder facilitates **very quick drawing** of the baton by tilting it out **with one hand**.

It also includes a **safety lock** which prevents the unexpected dropping of the baton. The holder is made from **highly resistant plastic**.

The holder makes it possible to insert an expanded baton into the holder when the user needs to free his or her hand for another activity.



UNLOCKED



LOCKED

BH-x4 BH-x5

Plastic holder for expandable baton

This plastic holder was granted European patent. It is designated for **professional use** and enables:

- very quick drawing of the baton **just with one hand** as there is almost no friction when the nylon strap is unfastened and the holder automatically opens,
- when the nylon strap is unfastened, the holder enables **carrying of expanded baton**.



Designation of the holder

for lengths of batons 16", 18", 21"		for lengths of batons 21", 23", 26"		Type of the fixation clip (see page 2)	Rotation (360°)	Compatibility with MOLLE	Attachable with- out unbuckling the belt
BHU-04	BHU-05	BH-04	BH-05	UBC-01	●	X	●
BHU-14	BHU-15	BH-14	BH-15	UBC-02	●	alternatively	●
BHU-24	BHU-25	BH-24	BH-25	paddle Fobus	●	X	●
BHU-34	BHU-35	BH-34	BH-35	UBC-03	●	X	X
BHU-44	BHU-45	BH-44	BH-45	UBC-04	●	●	—
BHU-54	BHU-55	BH-54	BH-55	UBC-05	●	X	X
—	—	BH-64	BH-65	metal clip	X	X	●
BHU-74	BHU-75	BH-74	BH-75	UBC-07	●	●	—



SH-x21 Plastic holder for expandable baton

This plastic holder has been designed for **professional use**. Thanks to its unique **patented construction** it enables very quick drawing of the baton. The holder enables **carrying of expanded baton**.

for lengths of batons **16"**, **18"** or **21"**

Designation of the holder	Type of the fixation clip (see page 2)	Rotation (360°)	Compatibility with MOLLE	Attachable without unbuckling the belt
SH-21	UBC-01	●	X	●
SH-121	UBC-02	●	alternatively	●
SH-221	paddle Fobus	●	X	●
SH-321	UBC-03	●	X	X
SH-421	UBC-04	●	●	—
SH-521	UBC-05	●	X	X
SH-721	UBC-07	●	●	—



BH-02 BH-03 Plastic holder for expandable baton

This plastic holder can be attached to a belt **by slipping the belt through the opening** in the holder. The holder was granted **European patent** and enables:

- very quick drawing of the baton **just with one hand** as there is almost no friction when the nylon strap is unfastened and the holder automatically opens,
- possibility of modifying the size of the hole for belt and the inclination of the holder by cutting the plastic dividers,
- when the nylon strap is unfastened, the holder enables **carrying of expanded baton**.

for lengths of batons **16"**, **18"** or **21"** **BH-02**

for lengths of batons **21"**, **23"** or **26"** **BH-03**



BC-01 Metal clip for concealed carrying of hardened expandable baton

This metal clip can be easily attached to the expandable baton, enabling its **concealed carrying** on the belt outside or inside trousers or on a tactical vest.

This clip is designed for use with ESP hardened expandable batons with a rubber grip only. The clip is not designed for being removed from the baton and put back on repeatedly.



Additional hand strap for expandable baton

We can supply an additional hand strap for expandable batons (type ExB). The strap can be easily inserted **under the screw-on baton ending**. The baton can be thus used with or without the hand strap as needed.

↓ **AH-01**

AH-01 Multi-functional handle for baton accessories

This multi-functional handle makes it possible to **use numerous accessories** for expandable baton in case you don't own the expandable baton at this moment or you are not for some reason able to use it. Combining this handle with various accessories makes it possible to create very easily and quickly **a whole range of tools** suitable for example for motorists or rescue teams.

The handle has **the same thread at both ends**, which enables mounting of the whole series of accessories, such as the additional flashlight **BL-01 / BL-02 / BL-03**, shovel **BS-01**, crowbar **BCB-01**, small crowbar **BE-03** or the ending with a hidden spike **BE-04** or **BE-05**.

It can also be used as the second handle for the bolt cutter **BCT-01**.



ACCESSORIES FOR EXPANDABLE BATONS

BE-01 Baton conical rubber ending with a jut

Large conical ending of the handle. It greatly **increases the certainty of hold** on the baton. It can be easily mounted on the baton after unscrewing its original ending.

This ending has a **specially curved jut**, which allows hitting the adversary with the other side of baton. This is advantageous in situations where confined space makes it impossible to fully open the baton and use it.

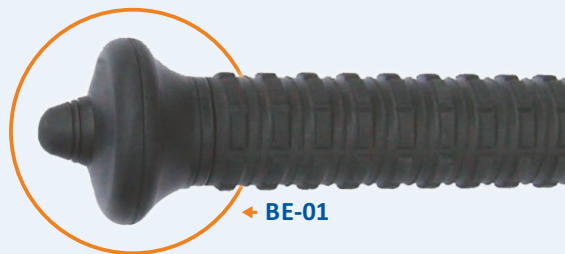

← BE-01

BE-02 Baton hardened steel ending

Baton ending made of **hardened steel**, which makes it possible to use the baton as an **impact tool**, e.g. for breaking of windows or as an improvised hammer. It can be easily mounted on the baton after unscrewing its original ending.



← BE-02 →

BE-03 Baton ending with a small crowbar

Baton ending in the form of a **small crowbar** is designated particularly for use by police and rescue teams. It can be easily mounted on the baton after unscrewing its original ending.

In this manner it is possible to very quickly create an alternative tool in emergency situations. It can be used for **prying open locks and latches**. Its end part can be used as a hammer. Dimensions: 80 × 28 mm, weight 215 g.



← BE-03 →

BE-04 BE-05 Baton ending with a hidden spike (glass breaker)

This rubber ending with a **hidden spike** is useful especially in emergency cases **for the destruction of obstacles made of glass**, for example during car accidents or police interventions. The ending is designated primarily for armed forces and rescue units, but also for ordinary drivers as an emergency tool for escaping from a vehicle in the case of an accident.

The special **hard and highly resistant** spike (tungsten carbide) is **safely hidden** in the ending right beneath the rubber surface. It **reliably shatters glass** even when limited force is applied. The ending can be easily mounted onto an expandable baton in the place of the standard ending.



← BE-04

↑ BE-05

BE-04: The **extended rubber part** of the ending improves grasp of the baton, prevents the hand from slipping and partially protects it against possible glass shard injury.

BE-05: This is a **more compact version** of the BE-04 ending.



Baton endings listed above are supplied separately as an accessory or upon request mounted on an expandable baton (except BE-03 ending).

BL-01 BL-02 Flashlight for expandable baton

- Can be used also independently as pocket light
- Burn time is up to **210 hours** for the type **BL-01**, up to **60 hours** for the type **BL-02**
- High luminous intensity thanks to **3 LED diodes**
- Power supply: **6 pcs** of lithium battery of the type **CR 2032** for the type **BL-01**, **2 pcs** for the type **BL-02**
- Waterproof duralumin body | Front glass made of **polycarbonate**
- **Service life** of LED diodes is **100 000 hours**
- Locking of end position (ON – OFF)



← BL-01 →



← BL-02



BL-03 Tactical flashlight for expandable baton

The ESP expandable baton can be equipped with this tactical flashlight which greatly broadens the possibilities of the baton's use. The **innovative CREE LED chip with 5W performance** ensures the **luminosity of up to 350 lm**. The flashlight is **waterproof** (it can be submerged in shallow water) and it can withstand rough handling.

The flashlight comprises an electronic module, which enables **4 modes** of lighting: **100 % / 50 % / 15 % / stroboscope**. You can switch between modes by quickly turning the body of the flashlight the same way as when switching the flashlight on. After a longer break (more than approx. 2 seconds) the flashlight returns to the mode of full output.

The flashlight can be also used without the expandable baton as a **common pocket flashlight**. The metal ring on the flashlight ending can be used to easily attach it to your gear or to your keyring. The flashlight is switched on by rotating the front part while the baton or the flashlight ending remain fixed. The rubber ring with bumps **prevents the flashlight from rolling** on a flat surface.

The flashlight is powered by the **18350 type battery** which **can be charged** in the **adapter with micro USB connector**. The adapter can be connected to a **charger from a regular smartphone** with the micro USB connector (this charger is not part of the package) or – using the cable supplied with the flashlight – the battery in the adapter can be charged **from a PC or a laptop**.

The flashlight can also be powered by the non-rechargeable battery **CR 123A** in combination with the plastic insert which compensates for the smaller diameter of the battery. This can be very useful as a back-up power source.

The flashlight is made from **highly resistant duralumin**. The front glass is made of **polycarbonate**. The flashlight length is 112 mm, the head diameter is 30 mm, the weight is 152 g (incl. battery). The flashlight attached to the baton lengthens its handle by 72 mm.

The package includes:

- BL-03 flashlight | 18350 battery
- Charging adapter
- Micro USB cable
- Plastic insert for the CR 123A battery



The adapter with micro USB can be connected to a charger from a regular smartphone



BLH-01 BLH-02 Nylon holder for baton flashlight

Nylon holder suitable for baton flashlight of the type **BL-01 / BL-02 (BLH-01)** or **BL-03 (BLH-02)** has a **Velcro seal**. It is equipped with a **metal clip**, which enables its **rapid attachment** to a belt (without the necessity of unbuckling it) or to a tactical vest. It can be alternatively fastened also to a **MOLLE webbing**.



BLH-01 →

BNS-01 BNS-02 BNS-03 Night police set for expandable baton

Flashlights **BL-01, BL-02** or **BL-03** make it possible to create a **"Night police set for baton"** consisting of red plastic signal cone, **BL-01, BL-02** or **BL-03** flashlight and the nylon pouch **BLH-01** or **BLH-02**.

The main advantage of this solution is the fact that the signal cone **does not take any extra space** in the pouch when the flashlight is inserted into it. At the same time it strengthens the pouch and thus **increases the protection** of the flashlight.

The cone is open at its top, which enables normal use of the flashlight for lighting with white light without the necessity of removing the cone (useful for checking personal documents, the interior of a vehicle, etc.). An excellent tool, not only for traffic police.



← BNS-01



← BNS-02 →

M-2 M-3 Tactical mirror for expandable baton

Expandable batons can be fitted with tactical mirrors of **two sizes**. These mirrors will enable you to for example check for the presence of an aggressor behind the corner or in the room you are about to enter. The mirror is equipped with a **clip for easy fitting** on the steel tube of the baton.

Type	Diameter of reflective surface	Weight
M-2	71 mm / 2,80"	23 g
M-3	92 mm / 3,62"	56 g

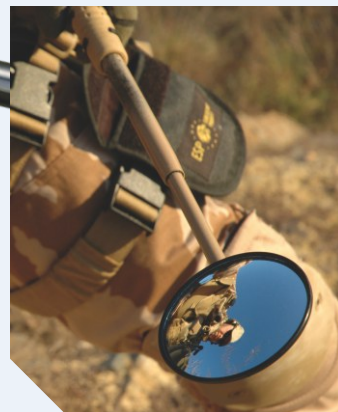

Nylon holder for tactical mirror

This nylon holder, which can be optionally supplied, protects the mirror against damage and enables its carrying on the belt.

It is equipped with **metal clip**, which enables its rapid attachment to a belt (without the necessity of unbuckling it) or to a tactical vest. It can be alternatively fastened also to **MOLLE webbing**.

BWB-01 Baton window breaker – special impact ending for expandable baton

Mounting of this ending on the baton is very quick and easy. It is designated for **forced entries** into objects and vehicles during police and rescue operations.

The head is made of high quality **hardened steel** and it is equipped with a plastic fixing centre.

Dimensions: \varnothing 48 × 56 mm, weight 235 g.



BWBH-01 Nylon holder for special impact ending

Nylon holder suitable for baton impact ending **BWB-01** has a **Velcro seal**. It is equipped with **metal clip**, which enables its rapid attachment to a belt (without the necessity of unbuckling it) or to a tactical vest. It can be alternatively fastened also to a **MOLLE webbing**.



BCB-01-A BCB-01-N Crowbar for expandable baton

The crowbar is designated for use by police or rescue teams. It can be used for prying open locks and latches, removal of nails or for hammering. This crowbar can be easily mounted on the baton after unscrewing its original ending. In this manner it is possible to very quickly create an alternative tool in emergency situations.

The version for armed services **BCB-01-A** is equipped with side profiles, which serve for **breaking the inserts** of ordinary locks.

Dimensions: 170 × 48 mm, weight 850 g.

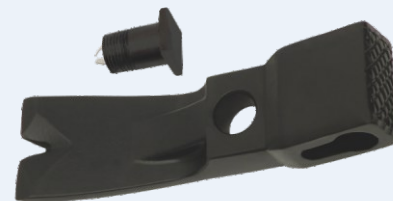

BCBH-01 Nylon holder for the crowbar

This special nylon holder serves for storage of the crowbar for the baton **BCB-01**. The top flap equipped with **fixing Velcro straps** protects the user from the sharp edge of the crowbar during transport.

The back of the holder is equipped with **reinforced straps** and it is accommodated for placing the whole set both on a duty belt or a tactical vest with **MOLLE webbing**.



BCT-01 Bolt cutter for expandable baton

The bolt cutter for expandable baton represents a comparatively compact accessory, which can be easily placed on a service vest. When combined with two **expandable batons**, which can be easily at hand in an ordinary two-member patrol, or with two **multi-functional handles**, a fully operational bolt cutter can be created very quickly.

It solves the problem of having to carry a whole bolt cutter along which would be far too cumbersome. The bolt cutter serves as a helpful aid during many interventions, military or rescue actions. For example, it can help cut a passage through a high fence or to overcome an obstacle made of barbed wire.

The maximum diameter of non-hardened wire it can cut is 6 mm. The weight without batons is 640 g, length 185 mm.

BCTH-01 Nylon holder for bolt cutter

This special nylon holder serves for storage of the bolt cutter for baton **BCT-01**. The top flap equipped with **fixing Velcro straps** **protects the user** from the sharp edge of the cutter during transport.

The back part of the holder is equipped with **reinforced straps** and it is accommodated for placing the whole set both on a duty belt or a tactical vest with **MOLLE webbing**.



BS-01 Shovel for expandable baton

It can be easily mounted on the baton after unscrewing its original ending. In this manner it is possible to very quickly create an alternative tool in emergency situations, which increases the possibilities of the ESP expandable baton.

This shovel was created for Army and Police Forces, rescue teams, but also for anybody who might happen to need to free a stuck car or for a camping enthusiast... The body of the shovel is made of **hardened steel**, edges of the shovel **are sharpened**.

The shovel can be mounted on the baton **in two locked positions**. Fully opened, it can be used like a normal shovel, spade or axe for cutting wood or clearing path through branches. When locked at right angle, it can be used as a hoe. Dimensions: 230 × 150 mm, weight 720 g.



BSH-01 Nylon holder for the shovel

This special nylon holder serves for storage of the shovel for the baton **BS-01**. The top flap equipped with **fixing Velcro straps** **protects the user** from the sharp edge of the shovel during transport.

The back of the holder is equipped with reinforced straps and it is accommodated for placing the whole set both on a duty belt or a tactical vest with **MOLLE webbing**.



EQUIPMENT FOR TRAINING

TB-21 TB-26 Training baton

Training batons are available in two lengths – **TB-21** (21") and **TB-26** (26"). They are highly wear resistant and their dimensions correspond to expandable batons of the length 21" and 26".

- **TB-21**: length 550 mm, weight 418 g | **TB-26**: length 660 mm, weight 504 g



TBT-21 TBT-26 Thin training baton

This thin training baton is a more rigid variant of the ESP training baton type **TB-21** or **TB-26**. Thanks to its slimmer and more rigid execution it enables training of various levers and fixations, which usually form an integral part of training of the armed forces.

- **TBT-21**: length 550 mm, weight 290 g | **TBT-26**: length 660 mm, weight 350 g

TBU-21 Closed training baton

This version of the training baton is made of **orange silicone** and its shape is identical with that of the closed real ESP expandable baton. It is designated primarily for the possible training of self-defense techniques, as well as for realization of various model situations.

Used material and manner of execution not only **considerably reduce the danger of injury** during contact training, but also prevent possible damage of the training mat. Thanks to its orange color, it is possible to recognize even at a distance that this baton is only a training aid. Length 210 mm, weight 170 g.



Training DVD "Expandable baton in practice"

This training DVD very illustratively explains the basic principles and elements of the use of the expandable baton and its accessories. It contains **16 chapters**, duration of film is **59 minutes**.



TT-24 Training tonfa

We can supply this training tonfa for training work, together with police tonfas. Its dimensions correspond to the police tonfa of the type **TR-24/59**.

HTB-01 Holder for training baton or tonfa

The holder serves for **rapid fixation** of the training baton or tonfa during training when the instructor needs to free his hands for explanation of some training elements. It contains a reinforced plate with **Velcro hooks**.

TS-60-95 TS-50-70 Training shock-absorbing bag

These bags have been designed for the baton and tonfa training use. They absorb even very strong hits. The cover is made of **highly damage resistant** material. It can withstand not only hits of training batons or training tonfas, but also hits of **hardened steel batons**, police tonfas or standard batons.



Type	Width	Height	Depth	Weight
TS-60-95	600 mm	950 mm	100 mm	4,7 kg
TS-50-70	500 mm	700 mm	100 mm	2,9 kg

TK-01 TKO-01 TK-02 TKO-02 Training knife

Plastic version of a commando knife comes in the form of a **dagger**. It serves for special defense training, as well as for the realization of model situations. Length 290 mm.

We offer also a shortened version of plastic training knife – type **TK-02**. Its dimensions correspond to the size of ordinary **pocket knives**. Length 220 mm.

They are manufactured in two variants of stiffness. The **stiffer version** is marked as **H (hard)**, and **softer version** is marked as **S (soft)**. They serve for different levels of training.



TK-01-H ↑



TKO-01-S ↑



TK-02-H ↑

TW-Glock 17 TW-Walther P99Q Training pistol

Training silicone pistol **Glock 17 / Walther P99Q** is designated for the safest possible training of self-defense techniques using the pistol or techniques using hits with the pistol.

The material and design not only **considerably reduce the danger of injury** during contact training, but they also prevent damage of wooden floor or training mats. **Signal orange color** easily distinguishes it from a real gun. **The edges are smoothed** in order to prevent injuries during contact.

The barrel is **reinforced** with a steel tube, which is safely hidden inside the silicone body of the pistol. This reinforcement prevents bending of the pistol and it gives it a better impression of a real gun.

- **TW-Glock 17**: weight 430 g | **TW-Walther P99Q**: weight 400 g

TW-Glock 17 →



← TW-Walther P99Q

TRAINING TORNADO Training spray flashlight

TRAINING JET Training defensive spray

Defensive spray **POLICE JET 63 ml** and spray flashlight **TORNADO 63 ml** are supplied also as a **training version** (containing harmless inert gas only). Spray cannot be refilled again.



STANDARD POLICE BATONS | TONFAS

The batons are made from the same durable material – **polypropylene** – as the plastic police tonfas. Although they are comparatively lightweight, they are **highly resistant to fracture**. The batons can be supplied either with or without **wrist strap**. It is also possible to choose the **PBS version with a protective shield**, which protects the hand against blows.

Lengths: **17" / 43 cm** | **19" / 48 cm** | **21" / 53 cm** | **23" / 58 cm** | **25" / 63 cm** | **27" / 68 cm** | **29" / 73 cm** | **31" / 78 cm** | **34" / 86 cm**



↑ PB-31/78-Hs



↑ PBS-31/78-Hs



↑ PB-17/43

ExT-20/52 ExT-24/61 Expandable tonfa

It is made of high-quality **duralumin** (type 6061). Hardened duralumin ensures high strength, toughness and resistance to oxidation (even in salt water).

It is **very compact when closed** and does not obstruct your movements. In case of need it can be drawn out very quickly to its full length.

- **ExT-20/52**: length 20" / 52 cm, weight 650 g | **ExT-24/61**: length 24" / 61 cm, weight 760 g



← ExT-20/52 ↑

TR-24/59 TF-24/59 Police tonfa

It was developed in cooperation with police experts and it is designated especially for professional use by police units and security agencies.

The tonfa is made of highly resistant polypropylene and has many improved features, which increase the confidence of the police officer in his or her self-defense (quality of grip, firmness, etc). The tonfas have received a quality certificate issued by testing laboratory at ITC Zlín, Czech Republic.

Type TR-24/59 is the standard round tonfa while type TF-24/59 has a special flat surface protecting the hand against a strike and during self-defense it helps spread the hitting power to a larger area.



TR-24/59-PC Polycarbonate police tonfa

This police tonfa is designated mainly for professional use by police forces and security agencies. The tonfa is made of high quality and high strength polycarbonate.

Type TR-24/59-PC has the shape of the standard round tonfa.



Type	Length	Weight
TF-24/59	23,2" / 59 cm	510 g
TR-24/59	23,2" / 59 cm	460 g
TR-24/59-PC	23,2" / 59 cm	610 g

Holders for TF tonfas



Holders for TR tonfas, ExT expandable tonfas and police batons



TH-x4-E TH-x4-C Plastic holder for expandable or standard tonfa

Plastic holder for expandable (-E) or standard (-C) tonfa is designated for professional use. It contains a safety lock, which prevents movement and spontaneous release of tonfa from the holder. Tonfa in the holder can be carried on the left or on the right side.

Designation of the holder	Type of the fixation clip (see page 2)	Rotation (360°)	Attachable without unbuckling the belt
TH-04-E TH-04-C	UBC-01	●	●
TH-14-E TH-14-C	UBC-02	●	●
TH-34-E TH-34-C	UBC-03	●	X
TH-54-E TH-54-C	UBC-05	●	X
TH-64-E TH-64-C	metal clip	X	●



PALM-STICK | TACTICAL PENS

KBT-01 Palm-stick

This inconspicuous means of defense, also known as *yawara*, *pasak* or *dulodulo*, is made from **tough plastic material** and serves to significantly **enhance the defensive abilities** of its users. The palm-stick can be used for **hits**, for **pressuring** the nerve points or for **levers**. Its central part is **knurled**, which prevents the palm-stick from slipping from your hand.

At the end it **has a metal ring** for a keyring. The palm-stick is supplied **with a string** allowing its fixation to 2 or 3 fingers, so that it remains in your hand when you need to grab the attacker. The length of the strings can be set according to the user's specification. Dimensions: length 155 mm, diameter 15 mm, weight 30 g.



KBT-02 KBT-03 Tactical pen ESP with a glass breaker

The tactical pen is a perfect combination of a **ballpoint pen** and **palm-stick**. It is an unobtrusive means of defense, which will always be at hand as it has the shape and form of an ordinary writing pen. You can use this pen to **hit** or **put pressure** on the neural points of the attacker. Its **ergonomic shape** and **grooves** ensure **sure grip**.

The screw cap is equipped with a **glass breaker** made of **tungsten carbide**. Thanks to this extremely hard metal you can **break glass barriers** even by a weaker strike. The cap also has a **clip** providing secure fastening of the pen e.g. in a breast pocket. The cap can be screwed onto both ends of tactical pen.

The pen is made of **duraluminum**, a **highly resistant material** used in the production of airplanes. The surface is further enhanced by **hard anodization**, which prevents it from scratches.

Replaceable cartridge with **blue ink** writes with line thickness of **0,5 mm**. The pen is supplied in an exclusive gift box.

Color: **black / titanium blue**. Tactical pen of the type KBT-02 is not sale-able in Germany.

Type	Length	Diameter	Weight
KBT-02	160 mm	15 mm	50 g
KBT-03	145 mm	14 mm	40 g



DOUBLE HOLDERS (EXAMPLES)



flashlight + pepper spray



magazine + flashlight



baton +
pepper spray



baton +
flashlight

SPRAY FLASHLIGHTS – PEPPER SPRAY WITH LED LIGHT

TORNADO represents a completely **new category of defensive sprays**, which at present has no equivalent on the market with defensive sprays. A super-bright flashlight with white LED diode was added to the standard defensive spray. Most of critical situations during which people defend themselves by defensive sprays take place in darkness.

It is impractical to hold a flashlight in one hand and a spray in the other. Moreover it is quite problematic to coordinate movements of both hands during critical situations. At the same time it is necessary to aim the spray precisely at the attacker's face and flashlight should therefore light the place where irritating gas should hit the adversary.

Our spray flashlights now make it possible to handle both flashlight and the spray **with one hand only** and to have the other hand free for better self-defense. The beam of light enables **precise aiming** at the target. The ESP company has contributed to the increase of the general level of self-defense by this significant innovation.



TORNADO AMONG SPRAYS

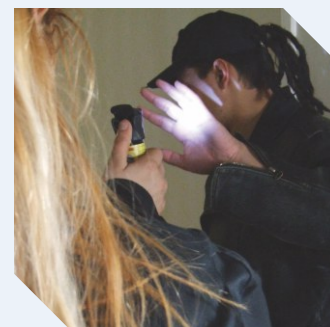

Features of TORNADO spray flashlights:

Special head with **super-bright LED diode** is mounted on a standard spray can. The covering cap, which prevents any unwanted shot of spray, contains two batteries CR 2032 and it serves at the same time also as a light switch. It is possible to use this spray flashlight in darkness **as an ordinary flashlight**. In case of danger you can immediately defend yourself just by pushing the button. The intense spotlight lights the aggressor's face and **blinds him**.

The system of head equipped with a LED flashlight has already been **patented** in the USA, in Europe and in Russia. The spray is shot out in the form of **JET**, that's why it is less susceptible to dispersion by possible mild wind. **Shooting range is approx. 4 m.**



POLICE TORNADO (SFL-01) – for professional use

This spray flashlight contains **Oleoresin Capsicum – 15% OC**. Chemical composition of the **non-flammable content** of the spray meets the requirements for pepper sprays **used by police forces (certificate according to the German standard)**, such as the guaranteed interval of working temperature from -20 °C to +50 °C, harmlessness, etc. Content of the spray can is manufactured by a renowned German company and its composition is identical to that used by the German police.

POLICE TORNADO 360° (SFL-01-45-360) – can be used in any position

Unlike the standard spray flashlights **SFL-01 POLICE TORNADO**, this version can spray **in any position**, i.e. even in the **upside down position**. Dimensions of the container correspond to **POLICE TORNADO 63 ml**, but its volume is only **45 ml**. All other parameters are identical. It is not continuously in stock and **it is supplied only for orders of at least 100 pieces.**

↕ K.O. TORNADO ↕



K.O. TORNADO (SFL-01.1)

This spray flashlight contains **non-flammable** solution of **Oleoresin Capsicum – 10% OC**.



Training version – TORNADO

Spray flashlight **TORNADO** is supplied also as a **training version** (containing harmless inert gas only) for training purposes. Spray cannot be refilled again.

	Designation of the spray flashlight	Volume	Diameter of the spray can	Height	Weight
POLICE TORNADO	SFL-01-40	40 ml	35 mm	105 mm	98 g
	SFL-01-50	50 ml	35 mm	128 mm	110 g
	SFL-01-63	63 ml	35 mm	137 mm	124 g
	SFL-01-100	100 ml	40 mm	165 mm	165 g
	SFL-01-45-360	45 ml	35 mm	137 mm	110 g
K.O. TORNADO	SFL-01.1-40	40 ml	35 mm	105 mm	98 g
	SFL-01.1-50	50 ml	35 mm	128 mm	110 g

HURRICANE FLASHLIGHT (SFL-02) Spray flashlight

This spray flashlight is based on the defensive pepper spray of the type **HURRICANE** (see below). This product is **patented** in the USA and in Europe. The miniature addition contains a complete flashlight with 4 batteries AG5 and a rubber sleeve. Available in black color or pink color (not saleable in Germany).

Thanks to its dimensions, spray flashlight HURRICANE FLASHLIGHT is **ideal for women**, as it takes only little space in a handbag. It can be an invaluable aid when they are in potentially dangerous surroundings.

When the **HURRICANE** spray can is emptied, the light module can be simply mounted on a **HURRICANE** spare can. Height 82 mm.

The model **SFL-02-C** is equipped with **metal clip** for fixing on a belt, etc.



SFL-02-C ↗

PEPPER SPRAYS

HURRICANE Pepper spray 15 ml

Pepper spray with volume of **15 ml** contains **Oleoresin Capsicum (10% OC)**. The spray is shot out in the form of **JET**, that's why it is less susceptible to dispersion by possible mild wind. Small dimensions, suitable for **ladies' handbags**.

It enables approx. 20 short jet shots at the **distance of 1–2 m**. Diameter of the can is 22 mm, height 82 mm.



Retractable holder (roller) for the HURRICANE self-defense spray

This holder with a **retractable string** facilitates comfortable carrying of the **HURRICANE** spray, making it always readily available. It can be attached to **almost anything** thanks to the **metal snap-hook and clip** on its back – to your clothes, to your bag or to your purse.

The spray will not get lost among other items and will always be in the same spot from which you can immediately take it and use it in the case of an emergency. An ideal solution for your sport activities or walking in the city.

It's almost impossible to lose the spray with this holder. If you accidentally drop the spray, the retractable mechanism **will return it** to its original place. The string can be extended up to the **length of 95 cm**.

It is also possible to use the holder **with sprays of different brands** with the can diameter of 22 mm. The holder is not designed for frequent removals of the spray but in the case of need, it is possible to remove the spray can from the holder using appropriate force.

POLICE JET Pepper spray 40 ml / 50 ml / 63 ml / 100 ml

Non-flammable pepper spray in volume of **40 ml, 50 ml, 63 ml** or **100 ml**. The spray head is equipped with a **cover lid** which prevents unwanted release of the spray. This pepper spray contains **Oleoresin Capsicum – 15% OC**.

Chemical composition of the **non-flammable content** of the spray meets the requirements for pepper sprays **used by police forces (certificate according to the German standard)**, such as the guaranteed interval of working temperature from -20 °C to +50 °C, harmlessness, etc. Content of the spray can is manufactured by a renowned German company and its composition is identical to that used by the German police.

The spray is shot out in the form of **JET**, that's why it is less susceptible to dispersion by possible mild wind. **Shooting range is approx. 4 m**. Spray cannot be refilled.



40 ml

50 ml

63 ml

Volume	Diameter of the spray can	Height	Weight
40 ml	35 mm	100 mm	83 g
50 ml	35 mm	123 mm	94 g
63 ml	35 mm	132 mm	108 g
100 ml	40 mm	160 mm	149 g

PEPPER JET Pepper spray 40 ml / 50 ml

Non-flammable pepper spray in volume of **40 ml / 50 ml** contains **Oleoresin Capsicum (10% OC)**. The spray is shot out in the form of **JET**, that's why it is less susceptible to dispersion by possible mild wind.

Striking distance of the spray jet is up to 4 m.
Spray cannot be refilled again. Made in Germany.

Volume	Diameter of the spray can	Height	Weight
40 ml	35 mm	86 mm	98 g
50 ml	35 mm	108 mm	110 g



Real test of our pepper sprays



KO-FOG Pepper spray 50 ml – FOG

Pepper spray with volume **50 ml** is sprayed out in the form of **FOG**. It does not require exact aiming as it creates a cloud, but it is susceptible to dispersion by wind. **Active range of spray approx. 4 m.**

Diameter of the spray can is 35 mm, height 110 mm. Spray cannot be refilled again. Made in Germany.



SPP-01 Pepper spray in the form of pen

Inconspicuous, always at hand. When closed, it looks exactly like an ordinary writing pen. It contains **Oleoresin Capsicum (10% OC)**.

It can produce approx. 20 short **JET** shots to the **distance of 1–2 m.**
Volume 14 ml. Length 144 mm. Made in USA.



TYPHOON Pepper spray 400 ml with reach up to 5–6 m

Professional, highly efficient pepper spray with volume of **400 ml** and with **reach up to 5-6 m** contains concentrated Oleoresin Capsicum (OC). The spray is shot out in the form of **JET**, that's why it is less susceptible to dispersion by possible mild wind.

Thanks to its volume it is designated particularly **for use at special actions against several attackers**, such as riots or rampage of soccer fans. Pepper spray meets the highest safety standards. Working temperature is within the interval from -20 to +50 °C.

Diameter of the vessel is 64 mm, height 256 mm (with handle), width 140 mm (at the place of handle). Spray cannot be refilled again. Made in Germany.



EHS-02 Decontamination first-aid spray

Unique system for **rapid and sterile cleaning and calming of the eyes** after application of pepper sprays and sprays with irritating substances. This decontamination spray with volume of **200 ml** can be of course used also to treat normal eye or skin irritation, as well as for surface cleaning of dirty wounds.

It may be applied from **any angle** (even horizontally or upside down). It will be handy particularly in security units which use defensive sprays. It can, however, find its place also in the medicine cabinet at home, as first aid for eye or skin irritation.

Diameter of the vessel is 52 mm, height 200 mm. Spray cannot be refilled again. Made in Germany.



CARRYING DEFENSIVE SPRAYS

SHT-x4 Plastic holder for spray flashlight TORNADO

This plastic holder is designated for **professional use**. It enables **very fast drawing** of the spray **sideways** from the holder. Moreover, it contains a **safety catch**, which holds the spray head firmly in the holder and at the same time prevents accidental opening of the lid.

In case of the spray flashlight **TORNADO** the safety catch thus prevents undesirable lighting or, when the opposite effect is desired, it makes it possible to **fix the spray lid in the lighted position** and thus use the **TORNADO** spray as an improvised flashlight.

In vertical or slightly inclined position it can be used for **permanent lighting** of space in front of the user, leaving his hands remain free.



↑ SHT-04-50.63 ↑

SHU-x4 Universal plastic holder for other defensive spray

This plastic holder is designated for **professional use**. It enables **very fast drawing** of the spray **sideways** from the holder. Moreover, it contains a **safety catch**, which holds the spray head firmly in the holder.

Many types of pepper sprays of different brands and shapes of head fit our **SHU** and **SHUN** holders. You can find some examples on the next page.

SHUN-x4 Universal plastic holder without safety catch for other defensive sprays

This plastic holder is designated for **professional use**. It enables **very fast drawing** of the spray **sideways** from the holder.

This type of holder is designed for users who do not require a safety catch for the spray head.



SHU-44-50.63 →

SHT-14-50.63 →

↑ SHUN-64-50.63

Designation of the holder			Type of the fixation clip (see page 2)	Rotation (360°)	Compatibility with MOLLE	Attachable without unbuckling the belt
SHT-04	SHU-04	SHUN-04	UBC-01	●	X	●
SHT-14	SHU-14	SHUN-14	UBC-02	●	alternatively	●
SHT-24	SHU-24	SHUN-24	paddle Fobus	●	X	●
SHT-34	SHU-34	SHUN-34	UBC-03	●	X	X
SHT-44	SHU-44	SHUN-44	UBC-04	●	●	—
SHT-54	SHU-54	SHUN-54	UBC-05	●	X	X
SHT-64	SHU-64	SHUN-64	metal clip	X	X	●
SHT-74	SHU-74	SHUN-74	UBC-07	●	●	—



SHUN-24-50.63 ↑

Holders **SHT**, **SHU** or **SHUN** are produced in 4 variants:

- for spray cans with volume of **40 ml**
e.g. SHT-04-40 | SHU-14-40 | SHUN-24-40 ...
- adjustable for sprays with volumes **from 50 ml up to 63 ml**
e.g. SHT-34-50.63 | SHU-44-50.63 | SHUN-54-50.63 ...
- adjustable for sprays with volumes **from 75 ml up to 100 ml**
e.g. SHT-64-75.100 | SHU-74-75.100 | SHUN-04-75.100 ...
- adjustable for sprays with volumes **from 100 ml up to 130 ml**
e.g. SHU-14-100.130 | SHUN-24-100.130 ...



↑ SHT-x4-40





SHU-x4-40



SHUN-x4-40



SHUN-x4-50-63



Examples of sprays suitable for our SHU or SHUN holders



SHUN-x4-75-100



SHU-x4-50-63



SH-x4-35 SH-x4-38 Plastic holder for defensive spray

This plastic holder is designated for **professional use**. The holder enables **quick drawing** of the spray.

- SH-x4-35 for sprays with can diameter 35 mm
- SH-x4-38 for sprays with can diameter 38 mm

SH-64 →



← SH-04

SH-14 →

SHN-x4 Nylon holder for pepper sprays

The nylon holder for spray flashlights **TORNADO** and other defensive sprays has a **Velcro seal**. It has been designed for sprays of the diameter of 35 mm.

SHN-04-50 (50 ml) →



Volume of spray	Type of holder	Type of holder	
40 ml	SHN-x4-40	SHN-x4-TORNADO 40	for TORNADO 40 ml
50 ml	SHN-x4-50	SHN-x4-TORNADO 50	for TORNADO 50 ml
63 ml	SHN-x4-63	SHN-x4-TORNADO 63	for TORNADO 63 ml / 45 ml (360°)

Designation of the holder

... CHOOSE YOUR VOLUME ... OF SPRAY

Type of the fixation clip (see page 2)

Rotation (360°)

Compatibility with MOLLE

Attachable without unbuckling the belt

Designation of the holder	... CHOOSE YOUR VOLUME ... OF SPRAY	Type of the fixation clip (see page 2)	Rotation (360°)	Compatibility with MOLLE	Attachable without unbuckling the belt
SH-04	SHN-04-(ml) / SHN-04-TORNADO (ml)	UBC-01	●	X	●
SH-14	SHN-14-(ml) / SHN-14-TORNADO (ml)	UBC-02	●	alternatively	●
SH-24	SHN-24-(ml) / SHN-24-TORNADO (ml)	paddle Fobus	●	X	●
SH-34	SHN-34-(ml) / SHN-34-TORNADO (ml)	UBC-03	●	X	X
SH-44	SHN-44-(ml) / SHN-44-TORNADO (ml)	UBC-04	●	●	—
SH-54	SHN-54-(ml) / SHN-54-TORNADO (ml)	UBC-05	●	X	X
SH-64	SHN-64-(ml) / SHN-64-TORNADO (ml)	metal clip	X	X	●
SH-74	SHN-74-(ml) / SHN-74-TORNADO (ml)	UBC-07	●	●	—



SHN-64-40 (40 ml)

STUN GUNS

SCORPY Max Stun gun "2 in 1" ... 500 000 Volts + pepper spray

This device is suitable for **professional use**, thanks to the extra high electric power in combination with pepper (OC) or CS spray. Both electric discharge and spray are easy to **operate by one hand** only. This new combination of the proven security products will strongly increase the self-defense ability of the user. Power supply is ensured by **2 alkaline 9V batteries**.

SCORPY 200 Stun gun "2 in 1" ... 200 000 Volts + pepper spray

This device is suitable for use by **general public**. Although its dimensions are small, it generates strong electric power and it also contains a pepper spray. Both electric discharge and spray are easy to **operate by one hand** only. You are now able to instantly choose the proper defense to meet any attack or to combine both means of defense. Power supply is ensured by **1 alkaline 9V battery**.

POWER Max Stun gun 500 000 Volts with safety plug

This classic stun gun is designated – thanks to its high power output of **500 000 V** – for **professional use**. Power supply is ensured by **2 alkaline 9V batteries**.

Stun guns of the type **POWER** are equipped with a **safety plug**, which renders the device non-functional in case it is snatched out of your hand.

POWER 200 POWER Lady Stun gun 200 000 Volts with safety plug

This classic stun gun is designated – thanks to its small dimensions and strong electric power – for use by the **general public**. Power supply is ensured by **1 alkaline 9V battery**. Stun gun POWER Lady (pink color) is not saleable in Germany.

All types of ESP stun guns are equipped with a **safety switch** preventing any unintentional discharge.

SGH-x4 Plastic holder for stun guns POWER or SCORPY

This holder is designated for **professional use**. The holder comes adjusted by the manufacturer for the stun gun **POWER**. The user can easily accommodate the holder for **SCORPY** stun gun and during this modification it is also possible to choose whether the holder will be carried on the left or on the right side.

Designation of the holder

for stun guns of the type				Type of the fixation clip (see page 2)	Rotation (360°)	Compatibility with MOLLE	Attachable without unbuckling the belt
POWER 200	POWER Max	SCORPY 200	SCORPY Max				
SGH-04-P2	SGH-04-PM	SGH-04-S2	SGH-04-SM	UBC-01	●	X	●
SGH-14-P2	SGH-14-PM	SGH-14-S2	SGH-14-SM	UBC-02	●	alternatively	●
SGH-24-P2	SGH-24-PM	SGH-24-S2	SGH-24-SM	paddle Fobus	●	X	●
SGH-34-P2	SGH-34-PM	SGH-34-S2	SGH-34-SM	UBC-03	●	X	X
SGH-44-P2	SGH-44-PM	SGH-44-S2	SGH-44-SM	UBC-04	●	●	–
SGH-54-P2	SGH-54-PM	SGH-54-S2	SGH-54-SM	UBC-05	●	X	X
SGH-64-P2	SGH-64-PM	SGH-64-S2	SGH-64-SM	metal clip	X	X	●
SGH-74-P2	SGH-74-PM	SGH-74-S2	SGH-74-SM	UBC-07	●	●	–



← SCORPY Max



SCORPY 200 →

POWER Max →



POWER 200 →



← SGH-14



POWER Lady →



IMPACT RESISTANT POLICE SHIELDS

AS-60 ASU-60 ASUD-60 Police shield

ESP shield is made of high-quality, **extremely resistant polycarbonate** with thickness of **3 mm** (it can be increased upon request **up to 5 mm**). All ESP shields have **quality certificate** issued by testing laboratory at ITC Zlín, Czech Republic.

Inner ergonomically shaped reinforced plate **efficiently dampens impacts and vibrations** on holding hand. V-shaped form of the shield **conducts blows efficiently aside**. The rubber handles with deep reeding **ensure secure grip**.



ASR-60 ASRU-60 ASRUD-60 Police shield with a rounded front plate

This shield differs from the type **AS** or **ASU** or **ASUD** by the fact that the profile of its front plate is rounded, **not broken into vertical lines**. All other data are identical.



AS-60-100/L

ASR-60-100/R

Held by one hand – only in left or right hand (depending on the shield type) with possibility of support grip by free hand

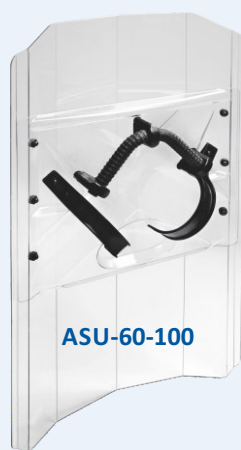

ASU-60-100

Can be held by either hand – universal (can be held only by one hand at one time)



ASU-60-130



ASU-60-160

knee pad

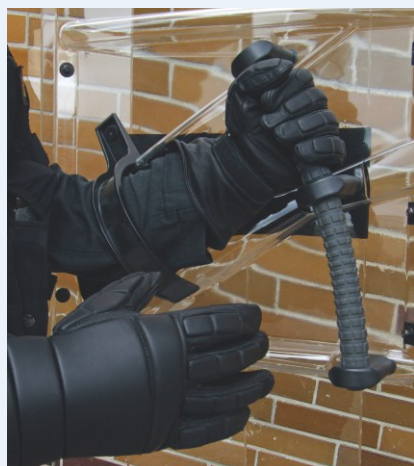

AS-60-100/L (held in left hand) ▲



ASRUD-60-100

Held by either hand (universal) with possibility of support grip by free hand

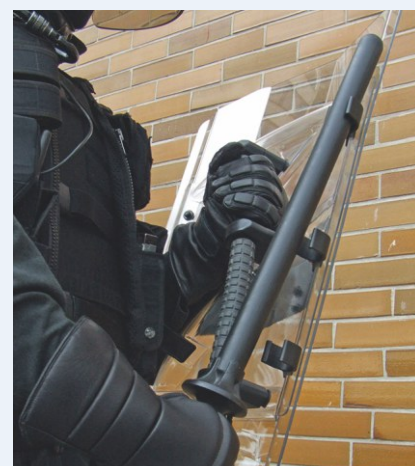

*The shields (except of the type **ASC**) can be equipped with the holder for baton (extra charge)*

Knee pad for police shield

130 cm and 160 cm police shields can be equipped with a knee pad which ensures **better comfort and stability** when holding the shield. The ergonomic shape of the knee pad **efficiently dampens the vibrations** from strikes into the legs of the user.

The knee pad also further strengthens the lower part of the shield. The knee pad can be supplied as an optional accessory for the shield for additional cost.



Designation of the shield		Width	Height	Weight	Holding of the shield
AS-60-100/L	ASR-60-100/L	570 mm	1 000 mm	3,50 kg	in left hand
AS-60-100/R	ASR-60-100/R	570 mm	1 000 mm	3,50 kg	in right hand
ASU-60-100	ASRU-60-100	570 mm	1 000 mm	3,65 kg	in left hand or in right hand
ASUD-60-100	ASRUD-60-100	570 mm	1 000 mm	4,25 kg	in left hand or in right hand
AS-60-130/L	ASR-60-130/L	570 mm	1 300 mm	4,15 kg	in left hand
AS-60-130/R	ASR-60-130/R	570 mm	1 300 mm	4,15 kg	in right hand
ASU-60-130	ASRU-60-130	570 mm	1 300 mm	4,30 kg	in left hand or in right hand
ASUD-60-130	ASRUD-60-130	570 mm	1 300 mm	4,90 kg	in left hand or in right hand
AS-60-160/L	ASR-60-160/L	570 mm	1 600 mm	4,80 kg	in left hand
AS-60-160/R	ASR-60-160/R	570 mm	1 600 mm	4,80 kg	in right hand
ASU-60-160	ASRU-60-160	570 mm	1 600 mm	4,95 kg	in left hand or in right hand
ASUD-60-160	ASRUD-60-160	570 mm	1 600 mm	5,55 kg	in left hand or in right hand



ASC-57-60 ASCU-57-60 Circle police shield

This shield is made of high-quality, **extremely resistant polycarbonate** (thickness **3 mm**). The shield has a **quality certificate** issued by testing laboratory at ITC Zlín, Czech Republic.

Inner ergonomically shaped reinforced plate **efficiently dampens impacts and vibrations** on holding hand. The rubber handles with deep reeding **ensure secure grip**.

Designation of the shield	Width	Height	Weight	Holding of the shield
ASC-57-60/L	570 mm	600 mm	2,00 kg	in left hand
ASC-57-60/R	570 mm	600 mm	2,00 kg	in right hand
ASCU-57-60	570 mm	600 mm	2,32 kg	in left hand or in right hand



ASC-57-60/L



ASCU-57-60

All our anti-riot shields can be supplied with a durable **sling for the arm** (instead of the standard plastic hook). The clip on the sling allows the user to quickly put the shield aside if necessary.



ASB-60-100 ASB-60-130

Protective cover for the anti-riot police shield

The cover protects the shield **during transport and storage**. It is made of high quality **rubberized fabric**. It has a handle and tiltable flap equipped with fixing **Velcro seal**.



www.esp-link.com/shield-ultimate-test



www.esp-link.com/shield-throwing-weapons

AS-W-60 ASU-W-60 ASUD-W-60

Interlocking anti-riot shield

The shield is equipped with interlocking components on its sides which enable **connecting** several shields **into one row**. The sides of the shields can be fit into one another within seconds, creating a sturdy protective barrier – a shield wall.

Another shield can be placed perpendicularly **on top of the shield**, providing the anti-riot team members protection from the top as well. Thanks to the specially shaped upper edge, the shields **fit very closely together** which significantly increases the safety of the protected persons.

In case of need, the shields can be **quickly disconnected again** and used separately.

Only the shields of the type AS-W can be interlocked, the locking of type AS is not possible.

165 cm Police Shields are equipped with a **knee pad** which ensures **better comfort and stability** when holding the shield. The ergonomic shape of the knee pad **efficiently dampens** the vibrations from strikes into the legs of the user. The knee pad also further reinforces the lower part of the shield.

The interlocking parts on the sides of the knee pad ensure **much tighter connection** between the tall shields (the shields are locked in the upper part near the handles and in the lower part near the knee). This knee pad is already **included in the price** of the shield.

Designation of the shield	Width	Height	Weight	Holding of the shield
AS-W-60-105/L	650 mm	1 050 mm	3,80 kg	in left hand
AS-W-60-105/R	650 mm	1 050 mm	3,80 kg	in right hand
ASU-W-60-105	650 mm	1 050 mm	3,95 kg	in left hand or in right hand
ASUD-W-60-105	650 mm	1 050 mm	4,55 kg	in left hand or in right hand
AS-W-60-165/L	650 mm	1 650 mm	5,40 kg	in left hand
AS-W-60-165/R	650 mm	1 650 mm	5,40 kg	in right hand
ASU-W-60-165	650 mm	1 650 mm	5,55 kg	in left hand or in right hand
ASUD-W-60-165	650 mm	1 650 mm	6,15 kg	in left hand or in right hand

ACS-60-120 Capture shield

This shield is made of extremely resistant polycarbonate with the thickness of **4 mm**. The shield plate is rounded.

The shield protects members of the police or prison guard in action and at the same facilitates **quick immobilization** of the uncooperative or aggressive person (by fixating them against the wall or on the ground). It is mainly meant for use **in closed spaces**, for example **prison cells**.

The two rubber handles with **deep reeding** ensure **secure grip**. The handles are sufficiently long for two people to hold the shield with both hands. Dimensions: 570 × 1 200 mm, weight 4,5 kg.

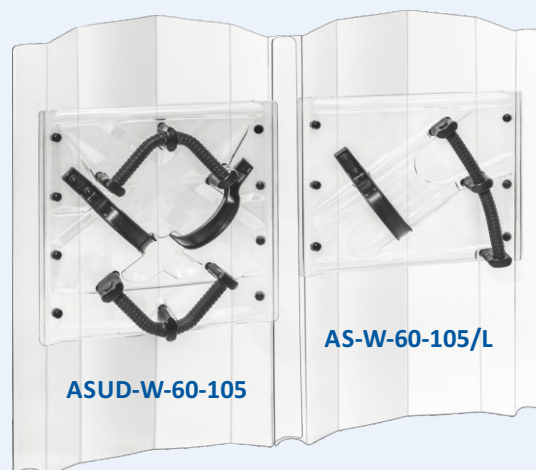
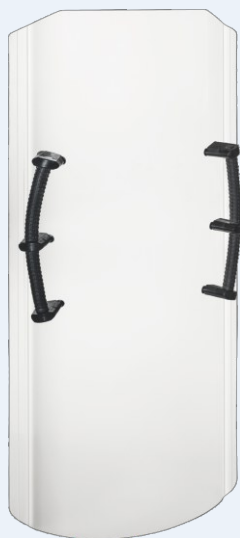

DETECTION MIRRORS

DM-160 DM-220 Detection mirror

This detection mirror serves for inspection of hazardous spaces and for under vehicle inspections. The mirror's curved shape is very advantageous as it **greatly increases the angle of observation**. The mirror is fixed to the rod with a **swiveling joint**, which makes it possible to adjust the angle of observation.

It uses duralumin **lightweight telescopic** rod, the length of which can be adjusted from 500 mm to 1 050 mm and then collapsed back to compact dimensions. **Anti-slip handle** enables safe grip. The mirror can be easily removed from the rod for easier transport.

The detection mirror can be supplied **with lighting** for inspection of darker spaces (*see below*). Detection mirror can be equipped also with a special handle, which considerably **reduces straining of arms** during its long-time use. Type **DM-220** is supplied only with this type of handle.

DMW-220 Detection mirror with a wheel

This detection mirror is equipped with a wheel which **significantly eases** the process of security checks. The wheel turns in all directions so you can **comfortably maneuver the mirror** into the desired spot – for instance beneath vehicles. The mirror's curved shape is very advantageous as it **greatly increases the angle of observation**. The wheel also helps support the weight of the mirror and does not strain the arm of the user during prolonged use.

The mirror is fixed to the rod with a **swiveling joint**, which makes it possible to adjust the angle of observation. At the other end of the ergonomically shaped steel rod with the wheel is a **rubber handle** for comfortable hold of the inspection mirror.

The **hand strap** at the top of the handle can be used either for the user's wrist or for hanging the mirror when not in use. The detection mirror can also be supplied **with lighting** which enables the user to inspect darker spaces.

Detection mirrors with lighting

All types of mirrors can be equipped **with a lighting** – it is possible to choose between 2 types of flashlights:

- **MAGNUM** with 14 LED – *see page 31*
- **TREX 5** with 5W Cree LED chip – *see page 30*

The flashlight is fastened directly to the mirror. It means that after the mirror is adjusted into the optimal angle, it is not necessary to further adjust the flashlight. Thanks to this the searched space will always be illuminated ideally.

The flashlight can be **easily removed** from the mirror and used separately. Power supply of both flashlights is ensured by 3 alkaline AAA batteries.

Strap for detection mirror (only DM-160 or DM-220)

Detection mirror can be equipped with an adjustable strap, so that the mirror can be hung on the shoulders when its user needs to free his hands for other activities (e.g. at the checkpoint in case of sudden need to grasp the gun).

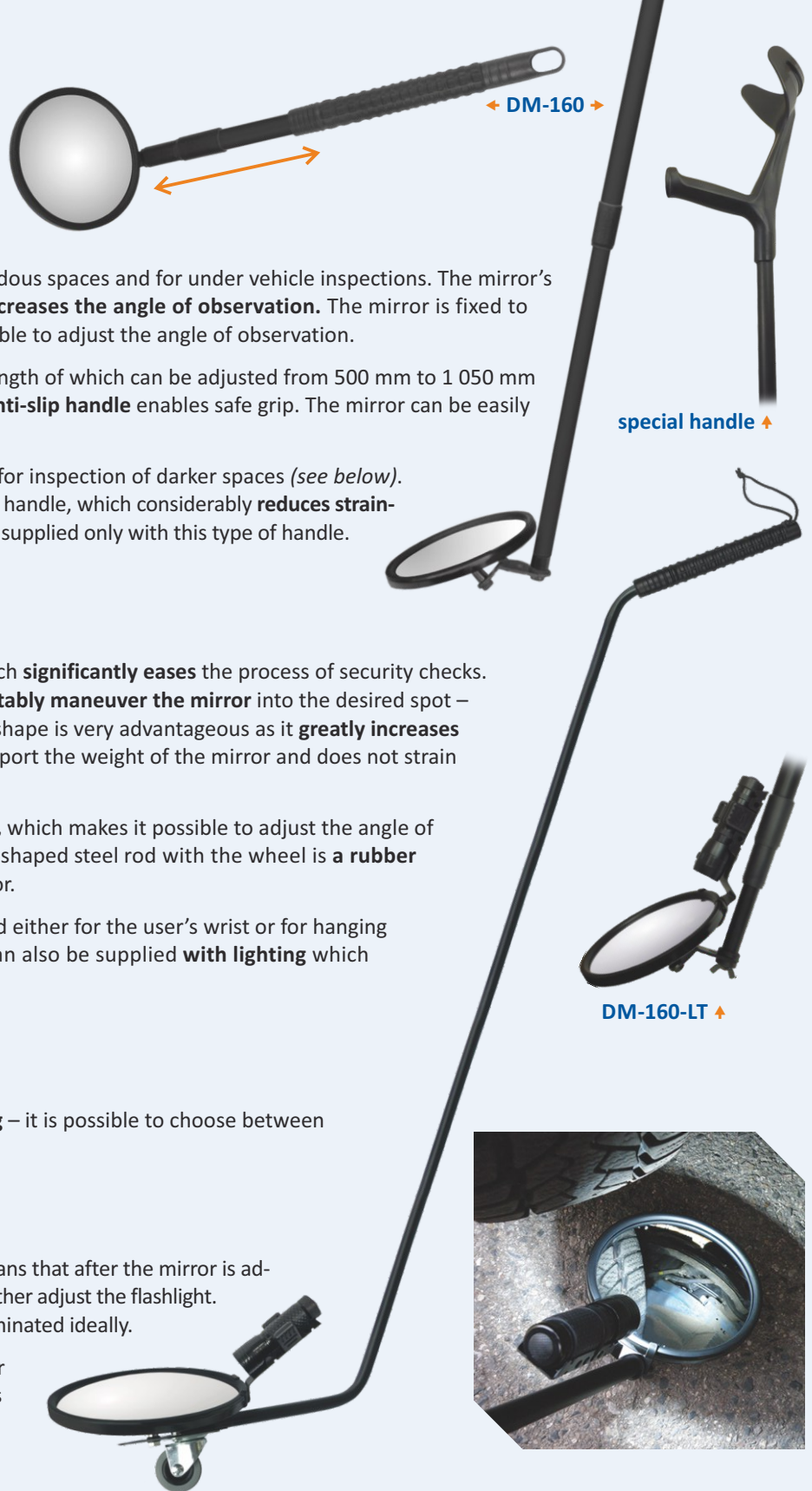

Designation of the mirror	Diameter of the mirror	Diameter of reflective surface	Lighting	Weight
DM-160	162 mm	145 mm	–	640 g
DM-160-LM	162 mm	145 mm	MAGNUM	900 g
DM-160-LT	162 mm	145 mm	TREX	900 g
DM-220	218 mm	204 mm	–	965 g
DM-220-LM	218 mm	204 mm	MAGNUM	1 225 g
DM-220-LT	218 mm	204 mm	TREX	1 225 g
DMW-220	218 mm	204 mm	–	1 696 g
DMW-220-LM	218 mm	204 mm	MAGNUM	1 925 g
DMW-220-LT	218 mm	204 mm	TREX	1 925 g

TEXTILE DISPOSABLE HANDCUFFS

HT-01-Y HT-01-B Textile disposable handcuffs

The handcuffs use a unique locking system, which ensures that even very physically strong individuals cannot get out from these handcuffs. Minimal tearing strength of the handcuffs is **140 kg** (verified by certified tests). Main advantages consist in **low weight** and **easy storage**.

This product is **patented in the USA** and **in Europe**. These handcuffs are **broadly used** by Police of the Czech Republic and Slovakia.

The bright **yellow** color of the handcuffs (**HT-01-Y**) enables easy identification of the handcuffed person. Handcuffs can also be made in **black** color (**HT-01-B**).

They are supplied in a set of 5 pieces. Weight 22 grams.

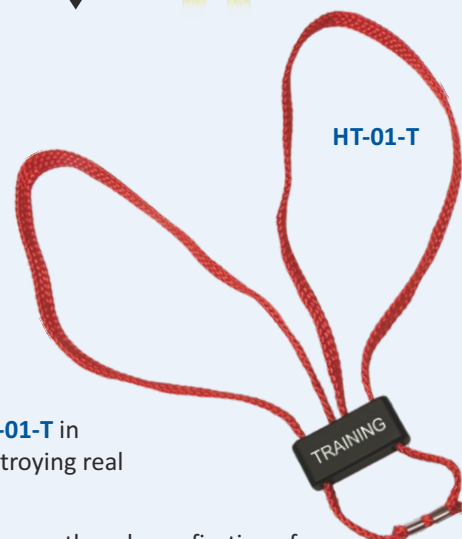
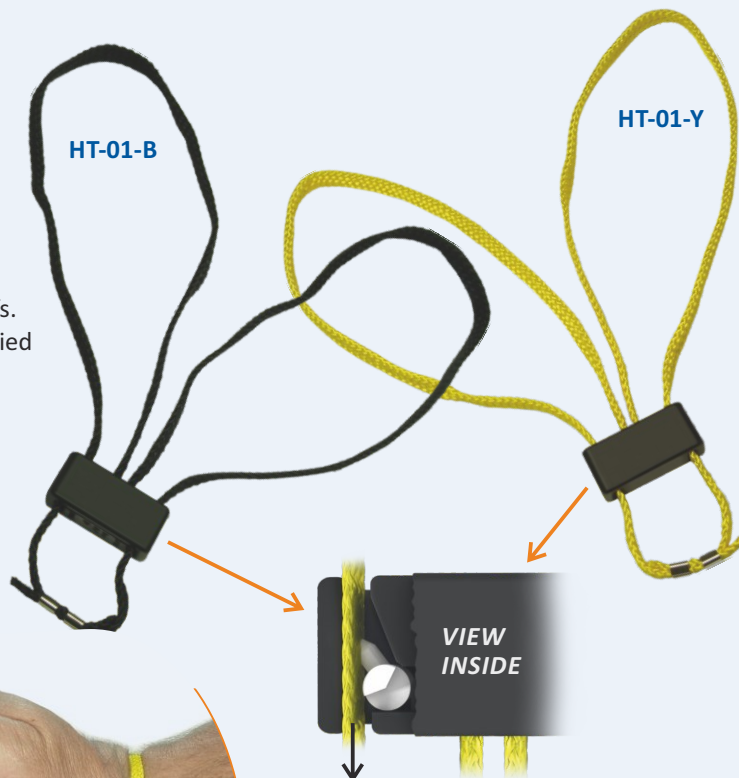

HT-01-T Training version of textile handcuffs

We offer together with disposable handcuffs **HT-01-Y** or **HT-01-B** also their **training** version **HT-01-T** in **red color**, which makes it possible to train handcuffing techniques without the necessity of destroying real disposable handcuffs.

Instead of fixation locks, these handcuffs are equipped with **silicone friction rollers**, which enable smooth and easy fixation of handcuffs. At the same time, the handcuffs remain realistically resistant when the handcuffed person tries to release himself or herself from them. They thus imitate the behavior of actual disposable handcuffs, but can be easily and safely taken off.

HK-02 HK-02-B Multi-purpose cutter for removal of disposable handcuffs

The cutter has an ergonomic shape with an opening for safe holding and also a hole for attachment to clothes or to a key-ring. The sharp edge of the cutter is embedded in order to prevent any injury during manipulation. Plastic lead-in part of the cutter with special shape enables its easy sliding under the handcuffs.

This cutter can be easily used for other purposes besides removal of disposable handcuffs. Thanks to the special shape of the blade it is possible to use this cutter also for rapid cutting of **car safety belts**, either in a car accident or during police crackdown on dangerous person sitting in the vehicle. The multi-purpose cutter **HK-02** can be also used for easy and safe removal of clothes during emergency first aid.

This multi-purpose cutter is also available **with a strap for comfortable carrying** on a **tactical vest** or a **duty belt**. Thanks to this you will have your cutter always at your disposal. The strap is manufactured from a **durable nylon** and can be attached to the duty belt **up to 55 mm in width** as well as to a **MOLLE webbing**.



HTH-x3 HTH-x6 HTH-x9 Plastic holder for 3, 6 or 9 pieces of textile handcuffs

This plastic holder is designated for comfortable daylong **carrying of larger number** of disposable textile handcuffs of the type **HT-01**. They are inserted into the holder after turning the top cover.

After opening of the side flexible flap the handcuffs can be quickly and easily taken out by pulling the textile ribbon. After it becomes empty, the holder can be easily filled with other handcuffs and be thus ready for another action.

The holder is made from **highly resistant polyamide** and it is manufactured in variants for 3, 6 or 9 pieces of textile handcuffs.

HTH-x3 →



↑ HTH-13

Designation of the holder

for 3 pieces of handcuffs	for 6 pieces of handcuffs	for 9 pieces of handcuffs	Type of the fixation clip (see page 2)	Rotation (360°)	Compatibility with MOLLE	Attachable without unbuckling the belt
HTH-03	HTH-06	HTH-09	UBC-01	●	X	●
HTH-13	HTH-16	HTH-19	UBC-02	●	alternatively	●
HTH-23	–	–	paddle Fobus	●	X	●
HTH-33	HTH-36	HTH-39	UBC-03	●	X	X
HTH-43	HTH-46	HTH-49	UBC-04	●	●	–
HTH-53	HTH-56	HTH-59	UBC-05	●	X	X
HTH-63	HTH-66	HTH-69	metal clip	X	X	●
HTH-73	HTH-76	HTH-79	UBC-07	●	●	–



← HTH-x9

METAL HANDCUFFS

HM-01 Stainless steel police handcuffs

These **chain handcuffs** are made from highly resistant **stainless steel**. It is **medically sound** and does not cause skin allergies (as compared to handcuffs with nickel or chrome surface cover).

The mechanical strength of the handcuffs **complies with the high demands of the NIJ 0307.01 standard**, the internationally recognized metal handcuffs performance test.

Thanks to a **double lock** the handcuffs are significantly more secure against attempts to unlock them. They are supplied with a **pair of keys** (standard universal key).

We recommend using our nylon holder with metal clip – **HMH-01** – for comfortable transport of the handcuffs. The holder protects the handcuffs from dirt and mechanical damage. Weight of handcuffs is 360 g.



pocket for spare key

HMH-01 Nylon holder for metal handcuffs

The holder is designated for **majority** of the types of used metal handcuffs. It is made of highly resistant and light, specially formed **nylon**. Inside the holder is a very useful **pocket for spare key**, thanks to which the key is always readily available.

On the back side it is equipped with **metal clip**, which enables its rapid attachment to a belt (without the necessity of unbuckling it) or to a tactical vest. It can be alternatively fastened also to a **MOLLE webbing**.



TACTICAL FLASHLIGHTS

HELIOS 10 Tactical police flashlight with 10W LED chip Cree XM-L2

Tactical flashlight with the **innovative Cree LED chip XM-L2** with **10W performance** ensures the luminosity of **up to 760 lm**. The flashlight is **waterproof** (it can be submerged in shallow water) and it can withstand rough handling.

The flashlight is made from **highly resistant duralumin**. The front glass is made of polycarbonate. Strongly grooved rubber head ring **prevents rolling** of the flashlight on smooth surface. Body diameter at the handle is 25 mm.

The metal switch is placed at the end of the flashlight. The switch is **tactical** – it can be pressed lightly for momentary output (lasting only through the duration of the pressure) or it can be pressed fully, switching the flashlight into constant output.

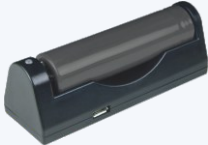
Power supply – package includes	Modes of lighting	Head diameter	Designation of the flashlight	Length	Weight (incl. batteries)
18650 battery, charging adapter, micro USB cable 	4 modes	34 mm	HELIOS 10-34-4R	141 mm	156 g
		37 mm	HELIOS 10-37-4R	153 mm	161 g
	1 mode	34 mm	HELIOS 10-34-R	141 mm	156 g
		37 mm	HELIOS 10-37-R	153 mm	161 g
2 pcs of non-rechargeable battery CR 123A 	4 modes	34 mm	HELIOS 10-34-4N	141 mm	156 g
		37 mm	HELIOS 10-37-4N	153 mm	161 g
	1 mode	34 mm	HELIOS 10-34-N	141 mm	156 g
		37 mm	HELIOS 10-37-N	153 mm	161 g



HELIOS 10 flashlights with 4 modes of lighting

This version of flashlight comprises an electronic module, which enables **4 modes of lighting**. Switching between individual modes is made **by short pressing** of tactical switch. The pressings must follow one another very quickly. At longer break (longer than approx. 2 seconds) the flashlight returns to the mode of full output.

1st pressing = **full output** | 2nd pressing = **stroboscope** | 3rd pressing = **half output** | 4th pressing = **battery saving mode**

HELIOS 10-37 flashlights

Compared to the **HELIOS 10-34** model, the **light beam of this flashlight is narrower** and can thus **illuminate an object at a greater distance**.

HELIOS 10 flashlights supplied with a charging adapter

The flashlight is powered by the **18650 type battery** which **can be charged** in the **adapter with micro USB connector**. The adapter can be connected to **a charger from a regular smartphone** with the micro USB connector (this charger is not part of the package) or – using the cable supplied with the flashlight – the battery in the adapter can be charged **from a PC or a laptop**.

The flashlight can also be powered by 2 pcs of non-rechargeable battery CR 123A in combination with the plastic insert (incl. in the package) which compensates for the smaller diameter of the battery. This can be very useful as a back-up power source.

HELIOS 10 flashlights supplied with non-rechargeable batteries

The flashlight is supplied with **2 pcs of non-rechargeable battery CR 123A** in combination with a plastic insert which compensates for the smaller diameter of the battery. Rechargeable batteries (type 18650) can also be used to power the flashlight.



HELIOS 3 ULTRAZOOM Tactical police flashlight with 3W LED chip Cree

Tactical flashlight with 3W LED chip Cree ensures the luminosity of **up to 200 lm**. The flashlight can withstand rough handling.

This version of flashlight is fitted with a special lens that allows **re-focusing between narrow and wide light beam**. When narrow cone of light is used, it illuminates a surface with **diameter of only 60 cm at a distance of 10 m!**

The flashlight is made from **highly resistant duralumin**. Strongly grooved rubber head ring **prevents rolling** of the flashlight on smooth surface. The metal switch is placed at the end of the flashlight. The switch is **tactical** – it can be pressed lightly for momentary output (lasting only through the duration of the pressure) or it can be pressed fully, switching the flashlight into constant output.

Head diameter 37 mm, body diameter at the handle 25 mm. Length 137 mm, weight including batteries 164 g.



Designation of the flashlight	Modes of lighting	Power supply – package includes
HELIOS 3-4R ULTRAZOOM	4 modes	18650 battery, charging adapter, micro USB cable
HELIOS 3-R ULTRAZOOM	1 mode	
HELIOS 3-4N ULTRAZOOM	4 modes	2 pcs of non-rechargeable battery CR 123A
HELIOS 3-N ULTRAZOOM	1 mode	



Flashlights with several lighting modes – HELIOS 3 ULTRAZOOM | BARRACUDA 5

This version of flashlight contains an electronic module which enables **several modes of lighting**. Switching between individual modes is made **by short pressing** of tactical switch. The pressings must follow one another very quickly. At longer break (longer than approx. 2 seconds) the flashlight returns to the mode of full output.

- **HELIOS 3 ULTRAZOOM** 100 % | stroboscope | 50 % | 15 % (battery saving mode)
- **BARRACUDA 5** 100 % | stroboscope | 50 %

Flashlights supplied with a charging adapter – HELIOS 3 ULTRAZOOM | BARRACUDA 5

The flashlight is powered by the **18650 type battery** which **can be charged** in the **adapter with micro USB connector**. The adapter can be connected to **a charger from a regular smartphone** with the micro USB connector (this charger is not part of the package) or – using the cable supplied with the flashlight – the battery in the adapter can be charged **from a PC or a laptop**.

The flashlight can also be powered by 2 pcs of non-rechargeable battery CR 123A in combination with the plastic insert (incl. in the package) which compensates for the smaller diameter of the battery. This can be very useful as a back-up power source.

Flashlights supplied with non-rechargeable batteries – HELIOS 3 ULTRAZOOM | BARRACUDA 5

The flashlight is supplied with **2 pcs of non-rechargeable battery CR 123A** in combination with a plastic insert which compensates for the smaller diameter of the battery. Rechargeable batteries (type 18650) can also be used to power the flashlight.

BARRACUDA 5 Tactical police flashlight with 5W LED chip Cree XP-G

Tactical flashlight with the **innovative Cree LED chip XP-G** with **5W performance** ensures the luminosity of **up to 380 lm**. The flashlight is **waterproof** (it can be submerged in shallow water) and it can withstand rough handling.

The flashlight is made from **highly resistant duralumin**. The front glass is made of polycarbonate. Robust body of the flashlight has **ergonomic shape**. It enables also so called **“cigar holding”** together with weapon. Its grooved surface significantly enhances safe grip under any conditions. Strongly grooved head **prevents rolling** of the flashlight on smooth surface.

The metal switch is placed at the end of the flashlight. The switch is **tactical** – it can be pressed lightly for momentary output (lasting only through the duration of the pressure) or it can be pressed fully, switching the flashlight into constant output.

Head diameter 34 mm, body diameter at the handle 25 mm. Length 136 mm, weight including batteries 142 g.

Designation of the flashlight	Modes of lighting	Power supply – package includes
BARRACUDA 5-3R	3 modes	18650 battery, charging adapter, micro USB cable
BARRACUDA 5-R	1 mode	
BARRACUDA 5-3N	3 modes	2 pcs of non-rechargeable battery CR 123A
BARRACUDA 5-N	1 mode	



TREX 3 Tactical police flashlight with 3W LED chip CREE

Police tactical duralumin flashlight with advanced powerful **3W LED chip CREE** with extremely high luminosity of **up to 200 lm**.

Highly resistant dampness-proof duralumin body. Unbreakable frontal polycarbonate glass. Strongly grooved rubber head ring prevents rolling of the flashlight on smooth surface. The switch is on the bottom of the flashlight.

Power supply by 3 pcs of alkaline AAA batteries, which are included in the price. Dimensions: length 115 mm, body diameter at the handle 27 mm, weight 125 g (incl. batteries).

It can be also used as a part of the **“Night police set”** with plastic red signal cone and nylon holder. A swiveling holder of the type **LHU** (see below) is available for comfortable carrying of the flashlight.



Night police set TREX →

CARRYING FLASHLIGHTS

LHU-x4 Universal plastic holder for tactical flashlight

Universal plastic holder for tactical flashlight is designated for **professional use**. It enables **very quick** drawing of the flashlight by **tilting it out**.

It contains also a **safety lock** preventing spontaneous release of the flashlight. The flashlight in horizontal or slightly inclined position can be used **for permanent lighting** in front of the user, freeing thus his hands.

Design of this holder was already **patented** in the USA and in Europe.



← LHU-04-34

Designation of the holder				Type of the fixation clip (see page 2)	Rotation (360°)	Compatibility with MOLLE	Attachable without unbuckling the belt
LHU-04-34	LHU-04-37	LHU-04-43	LHU-04-47	UBC-01	●	X	●
LHU-14-34	LHU-14-37	LHU-14-43	LHU-14-47	UBC-02	●	alternatively	●
LHU-24-34	LHU-24-37	LHU-24-43	LHU-24-47	paddle Fobus	●	X	●
LHU-34-34	LHU-34-37	LHU-34-43	LHU-34-47	UBC-03	●	X	X
LHU-44-34	LHU-44-37	LHU-44-43	LHU-44-47	UBC-04	●	●	—
LHU-54-34	LHU-54-37	LHU-54-43	LHU-54-47	UBC-05	●	X	X
LHU-64-34	LHU-64-37	LHU-64-43	—	metal clip	X	X	●
LHU-74-34	LHU-74-37	LHU-74-43	LHU-74-47	UBC-07	●	●	—

- the type **LHU-x4-34** is designated for flashlights with head diameter **up to 34 mm**
- the type **LHU-x4-37** is designated for flashlights with head diameter **up to 37 mm** and it enables **additional elongation** of the holder by 18 mm
- the type **LHU-x4-43** is designated for flashlights with head diameter **up to 43 mm** and it enables **additional elongation** of the holder by 18 mm
- the type **LHU-x4-47** is designated for flashlights with head diameter **up to 47 mm** and it enables **additional elongation** of the holder by 43 mm

Designation of the flashlight	Suitable type of the holder
HELIOS 10-34	LHU-x4-34
HELIOS 10-37	LHU-x4-37
HELIOS 3 ULTRAZOOM	LHU-x4-37
BARRACUDA 5	LHU-x4-34
TREX 3	LHU-x4-34



↑ LHU-x4-47

← LHU-64-37



↑ LHU-24-34



LH-x4 LH-02 Plastic holder for tactical flashlight

Plastic holder is designated for **professional use**. The holder enables a **quick drawing** of the flashlight. The flashlight in horizontal or slightly inclined position can be used for **permanent lighting** in front of the user, freeing thus his hands.

This holder is designed for the flashlights **HELIOS 10** and **BARRACUDA 5**, as well as for flashlights of similar shape and dimensions **with body diameter of 25 mm**.

- **LH-02:** This holder can be attached to a belt by **slipping the belt through the opening** in the holder.

Designation of the holder	Type of the fixation clip (see page 2)	Rotation (360°)	Compatibility with MOLLE	Attachable without unbuckling the belt
LH-04	UBC-01	●	X	●
LH-14	UBC-02	●	alternatively	●
LH-24	paddle Fobus	●	X	●
LH-34	UBC-03	●	X	X
LH-44	UBC-04	●	●	—
LH-54	UBC-05	●	X	X
LH-64	metal clip	X	X	●
LH-74	UBC-07	●	●	—

LH-02 →

LH-04 →

↕ LH-14 ↕

MAGNUM Duralumin flashlight with 14 LED diodes

Durable duralumin flashlight resistant to moisture with **14 LED diodes**. Unbreakable frontal polycarbonate glass. The switch is at the flashlight ending. It gives high intensity light with wide rays.

Rubber coated handle. Color: black. **Three AAA alkaline batteries are included in the price**. Head diameter 34 mm, body diameter 30 mm, length 105 mm, weight 126 g (incl. batteries).

Night police set MAGNUM →

NPS-01 NPS-02 Night police set – MAGNUM or TRES 3

Flashlight **MAGNUM (14 LED diodes)** or **TRES 3** makes it possible to create so called **“Night police set”** consisting of plastic red signal cone, flashlight and nylon pouch with various fixing clips. The main advantage of this solution is in the fact that the signal cone does not take any extra space in the pouch as the flashlight is inserted into it.

At the same time it strengthens the pouch and thus increases the protection of the flashlight. The cone is open at its top, which enables normal use of the flashlight for lighting with white light without necessity of removing the cone (checking of documents, checking of interior of vehicle, etc.). Excellent tool, not only for traffic police.



↕ Night police set TRES 3

Designation of the police set (with MAGNUM)	Designation of the police set (with TRES 3)	Type of the fixation clip of the holder (see page 2)	Rotation of holder (360°)	Compatibility with MOLLE	Attachable without unbuckling the belt
NPS-01-04	NPS-02-04	UBC-01	●	X	●
NPS-01-14	NPS-02-14	UBC-02	●	alternatively	●
NPS-01-24	NPS-02-24	paddle Fobus	●	X	●
NPS-01-34	NPS-02-34	UBC-03	●	X	X
NPS-01-44	NPS-02-44	UBC-04	●	●	—
NPS-01-54	NPS-02-54	UBC-05	●	X	X
NPS-01-64	NPS-02-64	metal clip	X	X	●
NPS-01-74	NPS-02-74	UBC-07	●	●	—



↕ NPS-02-64 (with TRES 3)

BACKPACKS | BELTS

UTB-01 Tactical backpack

The ESP tactical backpack facilitates **easy transport of a large quantity** of useful equipment and ensures its **immediate availability** during police interventions or during emergency rescue actions.

Thanks to its **special design**, it is possible to put into this backpack in a well-organized manner the equipment exactly according to the needs and specific requirements of activities of the given unit.

Systemic design of the inside of the backpack using the **carrying system of straps** allows arbitrary fixation of the chosen equipment in a **modular way** – vertically and horizontally, with the use of plastic clips, metal clips or holders equipped with the **MOLLE system**.

The same carrying straps are situated also on the outside of the tactical backpack, which is also equipped with a **large Velcro pad** used to attach **identification label** – such as POLICE, SWAT, etc. Both front and back of the backpack also contain **special pockets**, into which you can place **ballistic protection**.

Dimensions of the backpack: 500 × 300 × 100 mm (height × width × depth).



DB-01 Duty belt

The belt is made from extremely durable material with **hemmed edges** and **plastic bracing** on the inside. The inner side of the belt is lined with **Velcro loops**. The width of the belt is **50 mm**.

The robust plastic **three-point buckle** ensures quick and secure fastening of the belt. The loose ends of the belt are bent and fixated by plastic loops.

The belt's design ensures its high durability even during demanding duty. Color: black.



Size	S	M	L	XL	XXL	XXXL
Waist size	75–95 cm	85–105 cm	95–115 cm	105–125 cm	115–135 cm	125–145 cm
Length of the belt	120 cm	130 cm	140 cm	150 cm	160 cm	170 cm



ACCESSORIES FOR FIREARMS

RAIL Picatinny weaver MIL-STD-1913

RAIL of NATO standard is designed for fixation of other possible accessories to the gun. **Hardened duralumin** (type 6061) ensures high strength, toughness and resistance to oxidation (even in salt water). It can be fastened to various guns, such as machine gun **vs. 58** or **AK-47**, which considerably increases combat value of these guns. Length 155 / 98 mm, width 21 mm, height 9 mm, weight 56 / 33 g.

Cover for the RAIL

Plastic cover for the RAIL with length 98 mm. It covers the whole **RAIL 98 mm** – if it is empty. The cover surface is **divided by grooves**, which make it possible **to cut the cover** and remove the redundant part and then cover the RAIL again. You can use 2 pieces of this cover for a longer **RAIL 155 mm**. Length 109 mm.

155 mm



98 mm



98 mm
(upper)



WR-25 WR-27 Mounting for tactical flashlight

The mounting serves for fixation of various types of tactical flashlights on the RAIL Picatinny weaver. **Hardened duralumin type 6061**. The type **WR-25** is designated for flashlights **HELIOS 10** and **BARRACUDA 5**, as well as for flashlights of similar shape and dimensions with diameter of **24,5 to 25,5 mm**, the type **WR-27** is designated for flashlight **TREX**, as well as for flashlights of similar shape and dimensions with diameter of **26,6 to 27,5 mm**.



LHR-25 Universal mounting for tactical flashlight on the gun barrel

Universal mounting for flashlights with **body diameter 25–27 mm** on gun with the **barrel 13–20 mm**. Made of hardened steel varnished with powder paint.



PS-01 PS-02 Pressure switch for tactical flashlight

Length 280 mm, it can be extended **up to 800 mm**. The type **PS-01** is determined for the flashlights **HELIOS 10** and **BARRACUDA 5**, the type **PS-02** is determined for flashlight **TREX**.



WG-01 Additional handle for grip of the gun

The handle is fastened to the gun on the **RAIL 98 mm** (vz. 58, AK-47). It significantly increases the firmness and stability of holding. It is fastened by its turning around the vertical axis. Head of the handle is made of **hardened duralumin type 6061**. The body of the handle is made of **black polyamide**. Unlike fully plastic handles this handle has higher resistance. It is successfully used by French forces in Afghanistan. Weight 116 g. Total length 100 mm. Length of the handle itself 87 mm.



PISTOL AND RIFLE MAGAZINE HOLDERS

MH-x4 Plastic holder for double stack magazine 9mm Luger

This self-locking universal holder is designated for carrying of broader range of double stack magazines **9mm Luger** for the most frequently used service guns used all over the world – such as **Glock | SIG Sauer P226/P229 | SW MP9 | Beretta M9 | Taurus 92/99 | CZ 75 Compact | Grand Power K100 | Walther P99 ...** When the special insert we can supply for an extra price is used, the holder can support the shortened magazines for the **Glock 26** handgun as well.

The holder enables a **quick drawing** of the magazine. The sophisticated design of the fixation spring will be appreciated not only by armed forces members, but also by shooters of action SHOOTING disciplines. Color: **black / khaki**.



MH-MH-x4 Double swiveling plastic holder for two magazines 9mm Luger

Double **swiveling** plastic holder consists of two holders **MH-x4** (for 9mm magazine) connected by special adaptor. Advantage of this solution consists in saving the space on the belt. Both holders rotate in respect to the belt simultaneously, while their mutual position remains unchanged. The adaptor makes it possible to accommodate easily the holders for carrying on the right or left side. The holder **can be rotated** in respect to the belt by **full circle of 360 degrees with 16 locking positions**.

↑ MH-x4-S

↑ MH-MH-24

Safety strap for magazine holder (9 mm Luger)

Magazine holders (9 mm Luger) can be equipped with a safety strap, which for example prevents the possibility of the magazine being yanked out by an aggressor or which may be required by the user's service regulations.

The design of the safety strap makes it possible to shorten it to fit the specific size of the magazine in use. The manufacturer supplies the magazine holder with the safety strap already attached – the type designation is extended by the letter **"S"** (e.g. **MH-04-S, MH-64-S...**).



MH-x4-M16

Plastic holder for magazine 5.56 of the rifle M16 / M4 / AR15

This self-locking universal holder is designated for the carrying of **majority of metal or plastic** (Magpul, Oberland Arms etc.) **magazines 5.56** for the rifles **M16 / M4 / AR15**.

The sophisticated design with fixation spring enables **quick drawing of the magazine** during combat re-loading. Each user can himself **set the desired holding force** of the magazine with the use of 3 spacers supplied with the holder. Color: **black / khaki**.

The holder can be used also for other magazines of assault rifles **based on the NATO standard** – such as:

British **SA80** | French **Famas** | Swiss **Sig 556** | Italian **Beretta AR70/90** | South Korean **Daewoo K2** | Austrian **AUG/A3** | Israeli **TAR21** | German **G36** with the appropriate adapter.

The holder will be appreciated not only by the shooters specializing in rifle IPSC disciplines, but also by **police officers** and **soldiers** who use similar weapons in their service.



↑ MH-x4-M16 →



MH-x4-AK

Plastic holder for magazine of the rifle AK-47 / AK-74

This self-locking **universal** holder is designated for carrying of **all standard magazines** for the rifle **AK-47** (caliber 7.62×39), **AK-74** (caliber 5.45×39) and **other magazines** based on the AK-47 construction.

The sophisticated design with **fixation spring** enables **quick drawing of the magazine** during **combat re-loading**. Each user can himself set the desired **holding force of the magazine** with the use of 3 spacers supplied with the holder. Color: **black / khaki**.

MH-x4-AK →



MH-x4-MP5

Plastic holder for magazine of the rifle HK MP5 / UZI

This self-locking universal holder is designated for very convenient placement of a back-up **magazine for 9mm** police submachine gun **HK MP5** and **UZI**.

The holder can also support the magazines for rifles of the type **AR15** (9mm Luger) or handguns with the **caliber .45 AUTO** and **.40 SW**.

The sophisticated design with **fixation spring** enables **quick drawing of the magazine**. Color: **black**.

↑ MH-x4-MP5 →



Designation of the holder

Designation of the holder					Type of the fixation clip (see page 2)	Rotation (360°)	Compatibility with MOLLE	Attachable without unbuckling the belt
MH-04	MH-MH-04	MH-04-M16	MH-04-AK	MH-04-MP5	UBC-01	●	X	●
MH-14	MH-MH-14	MH-14-M16	MH-14-AK	MH-14-MP5	UBC-02	●	alternatively	●
MH-24	MH-MH-24	MH-24-M16	MH-24-AK	MH-24-MP5	paddle Fobus	●	X	●
MH-34	MH-MH-34	MH-34-M16	MH-34-AK	MH-34-MP5	UBC-03	●	X	X
MH-44	–	–	–	MH-44-MP5	UBC-04	●	●	–
MH-54	MH-MH-54	MH-54-M16	MH-54-AK	MH-54-MP5	UBC-05	●	X	X
MH-64	–	–	–	MH-64-MP5	metal clip	X	X	●
MH-74	MH-MH-74	MH-74-M16	MH-74-AK	MH-74-MP5	UBC-07	●	●	–

TACTICAL TARGETS SERIES



No. 1

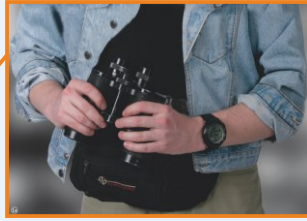

Dimensions of targets:
60 x 85 cm

These targets are possible to use in 5 different versions – "situations" which are created with 4 supplementary sheets.



No. 2



No. 3

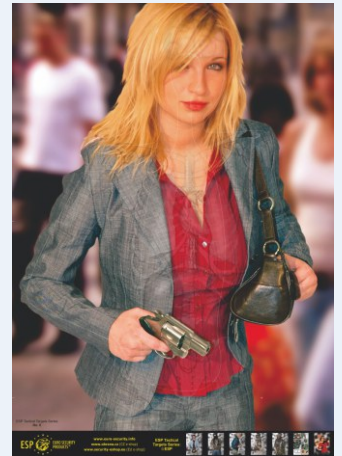

No. 6



No. 7 – SNIPER Target



No. 8 – Hostage and the Offender



EURO SECURITY PRODUCTS, s.r.o.

Hyacintova 20, CZ 106 00 Prague 10, Czech Republic

Tel. (English): +420 777 720 816 | +420 774 720 803

Tel. (Français): +420 732 375 846

Tel. (Deutsch): +420 777 720 805

E-mail: office@euro-security.info

www.euro-security.info



EuroSecurityProducts



EuroSecurityProducts



tradition since **1992**
ISO 9001 certification

Euro Security Products (ESP) is a well-known manufacturer of varied devices for professional use and for personal defense. The company is currently **one of the world's largest manufacturers** in the field of police and security equipment.

The history of this **Czech company** dates back to **1992** when it was established. A few years later – in 1996, the ESP company started to produce a wide range of **professional security products**. Our activity in the past years resulted in the development of new accessories, which represent an integrated set of devices intended for personal protection. Nowadays, Euro Security Products is one of the world's most important producers of self-defense and law enforcement equipment.

All ESP products are remarkable for their **sophisticated design**, state-of-the-art development process and **high reliability**. The **numerous patents** granted to the company confirm the uniqueness of its products. The ESP company is also a proud holder of the **ISO 9001 quality certificate**.

Over 90 percent of production is **exported into more than 60 countries** – not only to Europe (Germany, Italy, Spain, Portugal or Poland), USA and Russia, but also to such faraway countries as Mexico, India, Congo, China, etc. ESP products are used daily by a wide range of armed forces as well as the general public.

